

Superposition

(Stationary Waves)

TOPIC QUESTIONS (1)

Level	A Level
Subject	Physics
Exam Board	CIE
Paper Type	Multiple Choice

Time Allowed : 1Hour 10Min

EXAM PAPERS PRACTICE

1. The diagram represents the pattern of stationary waves formed by the superposition of sound waves from a loudspeaker and their reflection from a metal sheet (not shown).



W, X, Y and Z are four points on the line through the centre of these waves. Which statement about these stationary waves is correct?

- A. An antinode is formed at the surface of the metal sheet.
- B. A node is a quarter of a wavelength from an adjacent antinode.
- C. The oscillations at X are in phase with those at Y.
- D. The stationary waves oscillate at right angles to the line WZ.

2. A diffraction grating with N lines per metre is used to deflect light of various wavelengths λ . The diagram shows a relation between the deflection angles θ for different values of λ in the n th order interference pattern

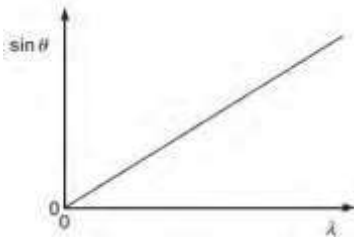

What is the gradient of the graph?

- A Nn B $\frac{N}{n}$ C $\frac{n}{N}$ D $\frac{1}{Nn}$

3. A stationary wave of frequency 80.0 Hz is set up on a stretched string of length 210 cm.

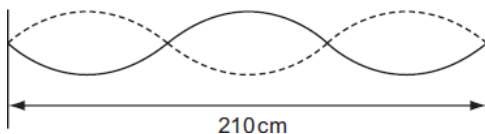

What is the speed of the waves that produce this stationary wave?
 A 56.0 m s^{-1} B 112 m s^{-1} C 5600 m s^{-1} D $11\,200 \text{ m s}^{-1}$

4. The order of magnitude of the frequency of the longest-wavelength ultraviolet waves can be expressed as 10^x Hz .

What is the value of x ?

- A 13 B 15 C 17 D 19

5. The light from two lasers passes through a vacuum. One laser emits red light and the other emits green light.

Which property of the two laser beams must be different?

- A amplitude B frequency
 C plane of polarization D speed

6. The diagram shows a standing wave on a string. The standing wave has three nodes N_1 , N_2 and N_3 .

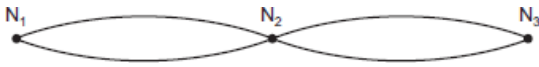

Which statement is correct?

- A All points on the string vibrate in phase.
- B All points on the string vibrate with the same amplitude.
- C Points equidistant from N₂ vibrate with the same frequency and in phase.
- D Points equidistant from N₂ vibrate with the same frequency and the same amplitude.

7. A parallel beam of light of wavelength 450 nm falls normally on a diffraction grating which has 300 lines / mm.

What is the total number of transmitted maxima?

- A 7
- B 8
- C 14
- D 15

8. Electromagnetic waves from an unknown source in space were found to be significantly diffracted when passing through gaps of the order of 10^{-5} m.

Which type of wave are they most likely to be?

- A radio waves
- B microwaves
- C infra-red waves
- D ultraviolet waves

9. Using monochromatic light, interference fringes are produced on a screen placed a distance D from a pair of slits of separation a. The separation of the fringes is x. Both a and D are now doubled.

What is the new fringe separation?

- A 2x
- B x
- C 2x
- D 4x

10. Diagram 1 shows a ripple tank experiment in which planewaves are diffracted through a narrow slit in a metal sheet. Diagram 2 shows the same tank with a slit of greater width.

In each case, the pattern of the waves incident on the slit and the emergent pattern are shown

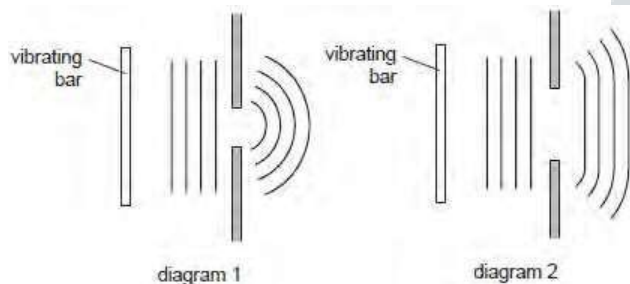

Which action would cause the waves in diagram 1 to be diffracted less and so produce an emergent pattern closer to that shown in diagram 2?

- A increasing the frequency of vibration of the bar
- B increasing the speed of the waves by making the water in the tank deeper
- C reducing the amplitude of vibration of the bar
- D reducing the length of the vibrating bar

11. Light of wavelength 600 nm is incident on a pair of slits. Fringes with a spacing of 4.0 mm are formed on a screen.

What will be the fringe spacing when the wavelength of the light is changed to 400 nm and the separation of the slits is doubled?

- A 1.3 mm
- B 3.0 mm

C 5.3 mm

D 12 mm



EXAM PAPERS PRACTICE

12. A teacher sets up the apparatus shown to demonstrate a two-slit interference pattern on the screen.

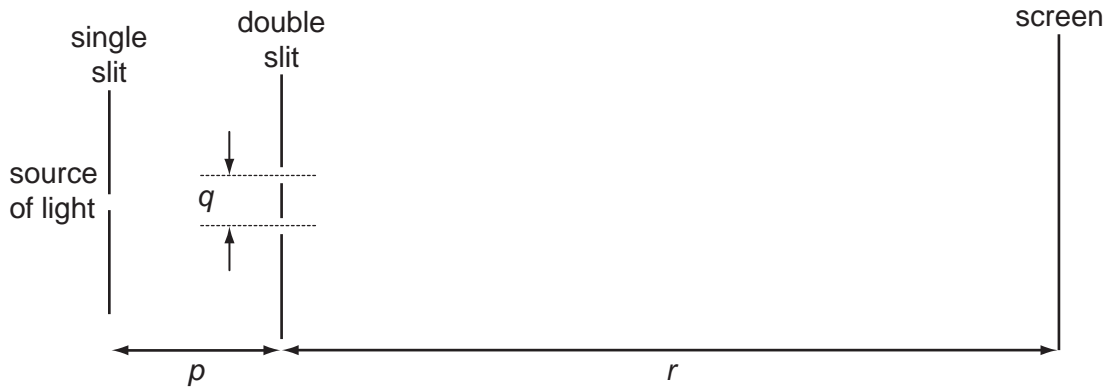

Which change to the apparatus will increase the fringe spacing?

- A decreasing the distance p
 - B decreasing the distance q
 - C decreasing the distance r
 - D decreasing the wavelength of the light
13. Monochromatic light of wavelength 5.30×10^{-7} m is incident normally on a diffraction grating. The first order maximum is observed at an angle of 15.4° to the direction of the incident light.

What is the angle between the first and second order diffraction maxima?

- A 7.6°
 - B 15.4°
 - C 16.7°
 - D 32.0°
14. A parallel beam of red light of wavelength 700 nm is incident normally on a diffraction grating that has 400 lines per millimetre.

What is the total number of transmitted maxima?

- A 3
- B 4
- C 6
- D 7

15. Monochromatic light is directed at a diffraction grating as shown.

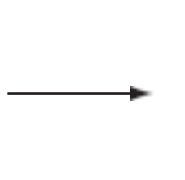

Which diagram shows all the possible directions of the light, after passing through the grating, that give maximum intensity?

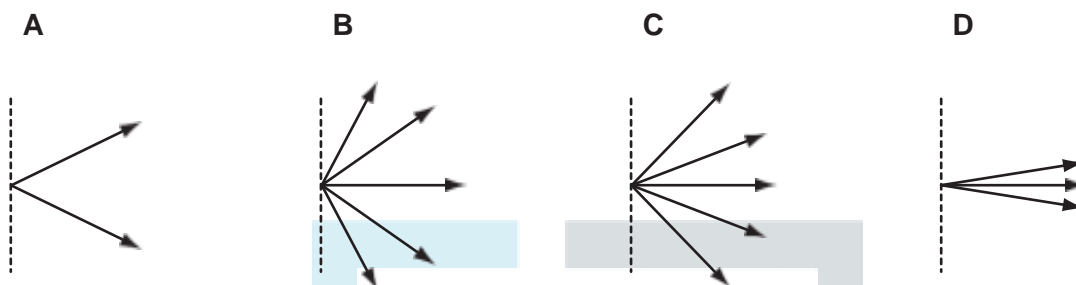

16. A standing sound wave is set up between a loudspeaker and a wall.

A microphone is connected to a cathode-ray oscilloscope (c.r.o.) and is moved along a line directly between the loudspeaker and the wall. The amplitude of the trace on the c.r.o. rises to a maximum at a position X, falls to a minimum and then rises once again to a maximum at a position Y.

The distance between X and Y is 33 cm. The speed of sound in air is 330 m s^{-1} .

Which diagram represents the c.r.o. trace of the sound received at X?

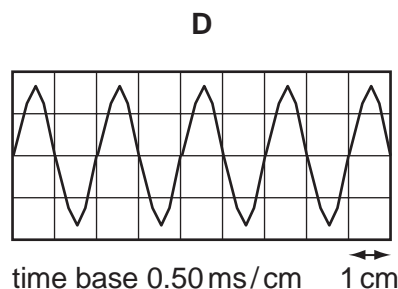
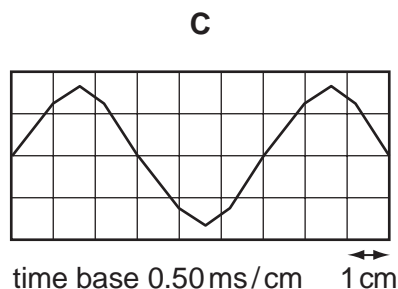
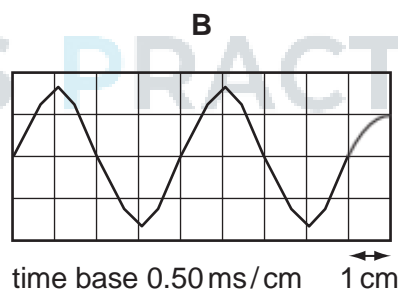
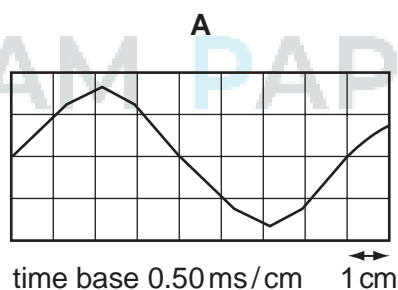

17. Travelling waves of wavelength 20 cm are created in the air columns in a closed pipe P and an open pipe Q. The lengths of the pipes are shown.

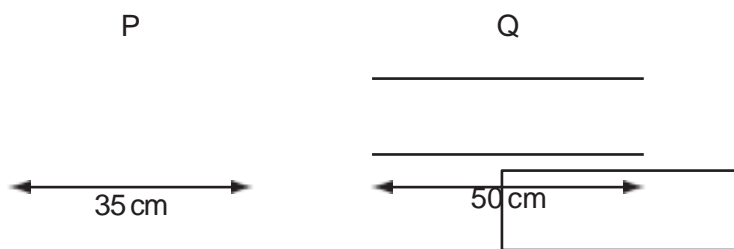

In which pipe or pipes are stationary waves formed?

- A P and Q
- B P only
- C Q only
- D neither P nor Q



EXAM PAPERS PRACTICE

18. A sound wave is set up in a long tube, closed at one end. The length of the tube is adjusted until the sound from the tube is loudest.

What is the nature of the sound wave in the tube?

- A longitudinal and progressive
- B longitudinal and stationary
- C transverse and progressive
- D transverse and stationary

19. The basic principle of note production in a horn is to set up a stationary wave in an air column.

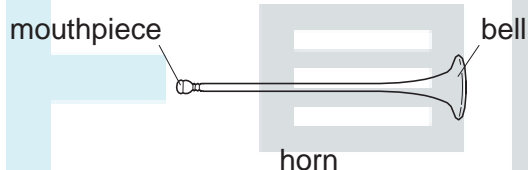

For the lowest note produced by a horn, a node is formed at the mouthpiece and the antinode is formed at the bell. The frequency of this note is 75 Hz.

What are the frequencies of the next two higher notes for this air column?

	first higher note /Hz	second higher note /Hz
A	113	150
B	150	225
C	150	300
D	225	375

20. A stationary wave is produced by two loudspeakers emitting sound of the same frequency.

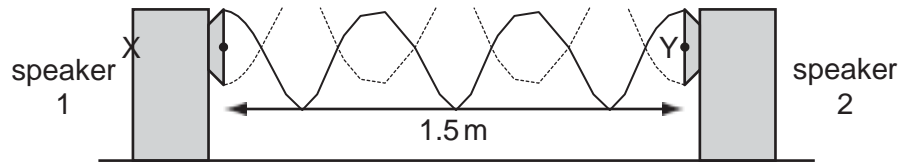

EXAM PAPERS PRACTICE

When a microphone is moved between X and Y, a distance of 1.5 m, six nodes and seven antinodes are detected.

What is the wavelength of the sound?

- A 0.50 m B 0.43 m C 0.25 m D 0.21 m

21. Sound waves, emitted by a small loudspeaker, are reflected by a wall. The frequency f of the waves is adjusted until a stationary wave is formed with the antinode nearest the wall at a distance x from the wall. Which expression gives f in terms of x and the speed of sound c ?

- A $f = \frac{4c}{x}$ B $f = \frac{2c}{x}$ C $f = \frac{c}{2x}$ D $f = \frac{c}{4x}$

22. A diffraction grating has N lines per unit length and is placed at 90° to monochromatic light of wavelength λ .

What is the expression for θ , the angle to the normal to the grating at which the third order diffraction peak is observed?

- A $\sin \theta = \frac{1}{3N\lambda}$ B $\sin \theta = 3N\lambda$ C $\sin \theta = \frac{N\lambda}{3}$ D $\sin \theta = \frac{3\lambda}{N}$

23. Light of wavelength 700 nm is incident on a pair of slits, forming fringes 3.0 mm apart on a screen. What is the fringe spacing when light of wavelength 350 nm is used and the slit separation is doubled?

- A 0.75 mm B 1.5 mm C 3.0 mm D 6.0 mm

24. The diagram shows two waves X and Y.

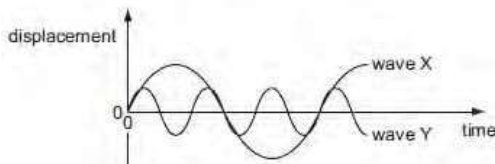

Wave X has amplitude 8 cm and frequency 100 Hz. What are the amplitude and frequency of wave Y?

	amplitude / cm	frequency / Hz
A	2	33
B	2	300
C	4	33
D	4	300

25. Light can exhibit all of the properties listed. Which property can sound not exhibit?

- A interference B polarisation
C refraction D total internal reflection

26. The diagram represents the screen of a cathode-ray oscilloscope displaying two sound waves labelled X and Y.

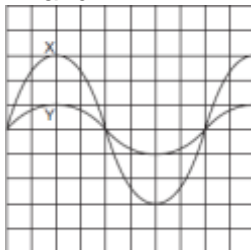

What is the ratio $\frac{\text{intensity of sound wave X}}{\text{intensity of sound wave Y}}$?

- A $\frac{9}{1}$ B $\frac{3}{1}$ C $\frac{\sqrt{3}}{1}$ D $\frac{1}{1}$

27. T is a microwave transmitter placed at a fixed distance from a flat reflecting surface S.



A small microwave receiver is moved from T towards S and receives signals of alternate maxima and minima of intensity.

The distance between one maximum and the next is 15 mm. What is the frequency of the microwaves?

- A 1.0×10^7 Hz B 2.0×10^7 Hz
 C 1.0×10^{10} Hz D 2.0×10^{10} Hz

28. The diagram shows two loudspeakers producing sound waves that are in phase.

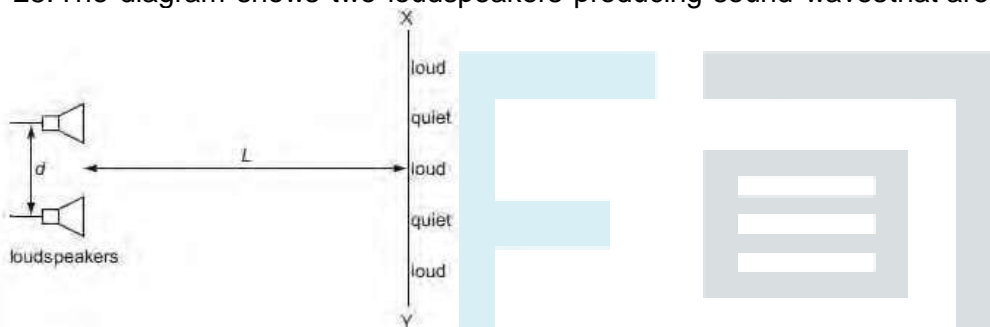

As a student moves from X to Y, the intensity of the note she hears is alternately loud and quiet. The distance between adjacent loud and quiet regions may be reduced by

- A decreasing distance d. B increasing distance L.
 C decreasing the amplitude. D increasing the frequency.

29. Diffraction is the name given to the

- A. Addition of two coherent waves to produce stationary wave pattern.
 B. Bending of waves round an obstacle.
 C. change of direction when waves cross the boundary between one medium and another.
 D. Splitting of white light into colours.

30. Which wave properties change when light passes from air into glass?

- A colour and speed B frequency and wavelength
 C speed and wavelength D wavelength and colour

31. The principle of superposition states that a certain quantity is added when two or more waves meet at a point.

What is this quantity?

- A amplitude
 B displacement
 C intensity
 D wavelength

32. Light passes through a diffraction grating ruled at 1000 lines per cm and the same wavelength of light also passes through two narrow slits 0.5 mm apart. Both situations produce intensity maxima and minima on a screen.

Which statement about the separation of the maxima on the screen and the sharpness of the maxima is correct?

- A The diffraction grating maxima are less widely spaced and are less sharp than the two-slit maxima.
- B The diffraction grating maxima are less widely spaced and are sharper than the two-slit maxima.
- C The diffraction grating maxima are more widely spaced and are less sharp than the two-slit maxima.
- D The diffraction grating maxima are more widely spaced and are sharper than the two-slit maxima.



EXAM PAPERS PRACTICE

33. The diagram shows an experiment which has been set up to demonstrate two-source interference. Microwaves of wavelength λ pass through two slits S_1 and S_2 .

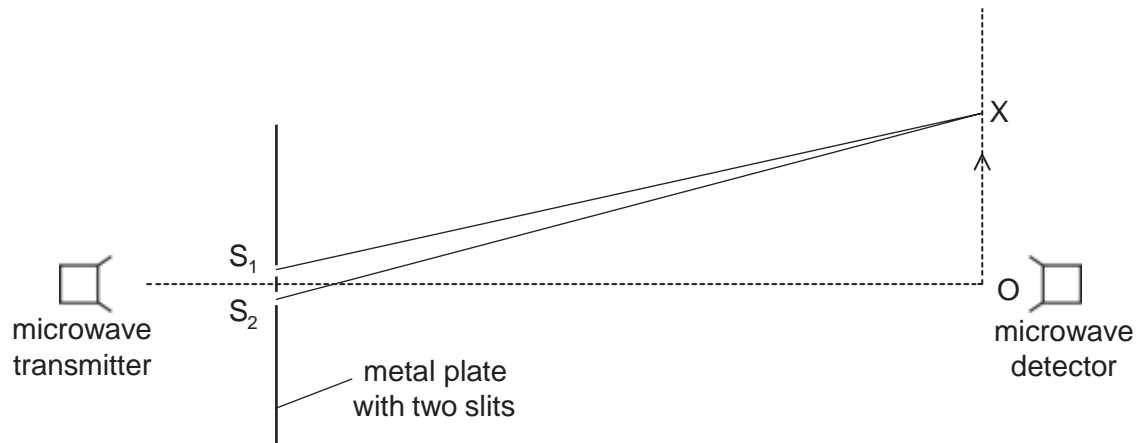

The detector is moved from point O in the direction of the arrow. The signal detected decreases until the detector reaches point X, and then starts to increase again as the detector moves beyond X.

Which equation correctly determines the position of X?

- A $OX = \lambda$
- B $OX = \lambda/2$
- C $S_2X - S_1X = \lambda$
- D $S_2X - S_1X = \lambda/2$

EXAM PAPERS PRACTICE

34. A stationary wave is set up on a stretched string, as shown.

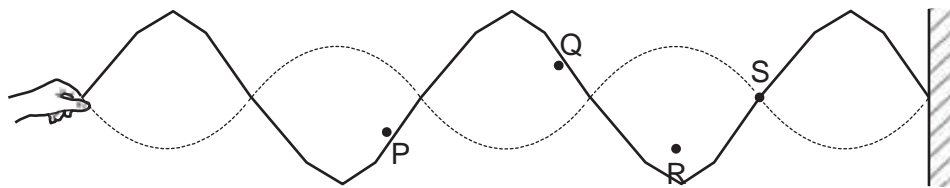

Which statement about the points on the string is correct?

- A Point Q vibrates with the largest amplitude.
- B Points P and R vibrate in phase.
- C Point S is an antinode.
- D The horizontal distance between R and S is half the wavelength.

35. A student attempts to show the interference of light using two identical green LEDs. Which statement explains why the experiment will not succeed?

- A The light waves from the sources are not coherent.
- B The light waves from the sources do not have the same amplitude.
- C The light waves from the sources have a range of wavelengths.
- D The light waves from the sources are not monochromatic

36. The three waves shown in each diagram have the same amplitude and frequency but differ in phase.

They are added together to give a resultant wave.

In which case is the resultant wave zero?



37. A stationary sound wave has a series of nodes. The distance between the first and the sixth node is 30.0 cm.

What is the wavelength of the sound wave?

- A 5.0 cm
- B 6.0 cm
- C 10.0 cm
- D 12.0 cm

38. The speed of a transverse wave on a stretched string can be changed by adjusting the tension of the string. A stationary wave pattern is set up on a stretched string using an oscillator set at a frequency of 650 Hz.

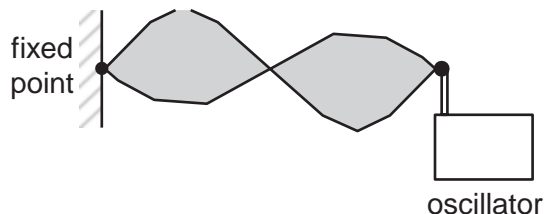

How must the wave be changed to maintain the same stationary wave pattern if the applied frequency is increased to 750 Hz?

- A Decrease the speed of the wave on the string.
- B Decrease the wavelength of the wave on the string.
- C Increase the speed of the wave on the string.
- D Increase the wavelength of the wave on the string.

39. Noise reduction headphones actively produce their own sound waves in order to cancel out external sound waves.

A microphone in the headphones receives waves of one frequency. A loudspeaker in the headphones then produces a wave of that frequency but of a different phase.

What is the phase difference between the external sound wave and the wave produced by the loudspeaker in the headphones?

- A 90°
- B 180°
- C 270°
- D 360°

40. A transmitter of electromagnetic waves is placed 45 cm from a reflective surface.

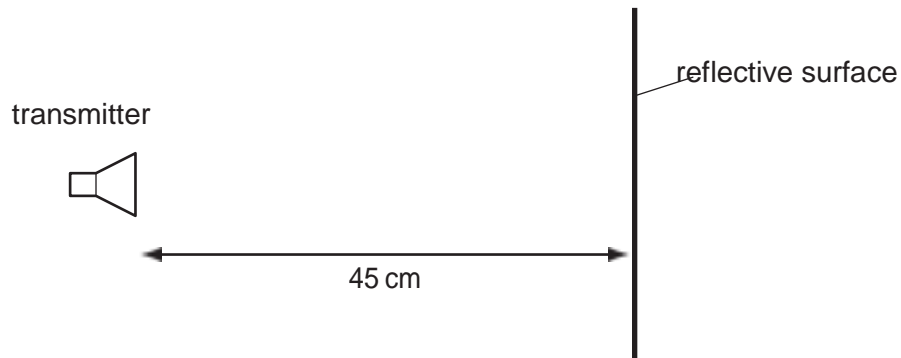

The emitted waves have a frequency of 1.00 GHz. A stationary wave is produced with a node at the transmitter and a node at the surface.

How many antinodes are in the space between the transmitter and the surface?

- A 1 B 2 C 3 D 4
41. The diagram shows a view from above of a double slit interference demonstration.
- L is a monochromatic light source with a vertical filament. B is a barrier with two narrow vertical slits and S is a screen upon which interference fringes form.

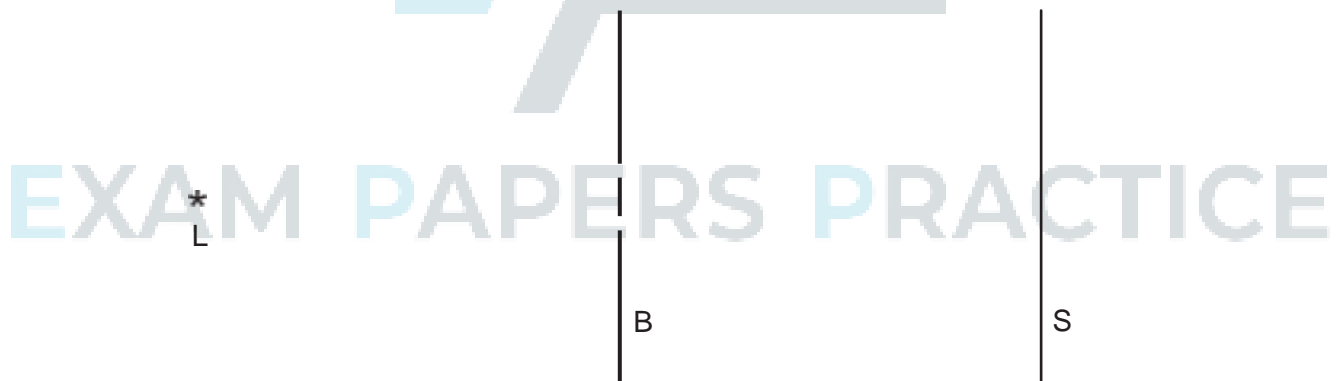

The intensity is I at a point on the screen where the centre of the fringe pattern forms.

What is the intensity, at the same point, when one of the slits is covered up?

- A $\frac{I}{\sqrt{2}}$ B $\frac{I}{2}$ C $\frac{I}{2\sqrt{2}}$ D $\frac{I}{4}$
42. Coherent waves are produced at P and at Q and travel outwards in all directions. The line RS is halfway between P and Q and perpendicular to the line joining P and Q. The distance RS is much greater than the distance PQ.



NOT TO
SCALE

X

S

Y

Along which line, or lines, is an interference pattern observed?

- A both RS and XY
- B RS only
- C XY only
- D neither RS nor XY



EXAM PAPERS PRACTICE

43. Two light sources produce visible interference fringes only in certain circumstances. Which condition enables visible interference fringes to be formed?

- A using a white light source
- B using incoherent sources
- C using one light source which is polarised at right angles to light from the other source
- D using sources from which the light does not overlap

44. Which electromagnetic wave phenomenon is needed to explain the spectrum produced when white light falls on a diffraction grating?

- A coherence
- B interference
- C polarisation
- D refraction

EXAM PAPERS PRACTICE

45. A diffraction grating with 500 lines per mm is used to observe diffraction of monochromatic light of wavelength 600 nm.

The light is passed through a narrow slit and the grating is placed so that its lines are parallel to the slit. Light passes through the slit and then the grating.

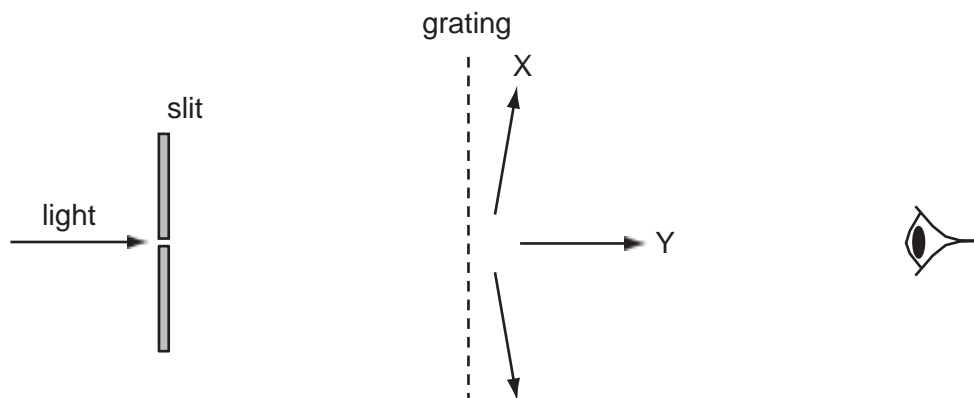

An observer views the slit through the grating at different angles, moving his head from X parallel to the grating, through Y, opposite the slit, to Z parallel to the grating on the opposite side.

How many images of the slit does he see?

- A 3 B 4 C 6 D 7

46. A stationary wave of frequency 80.0 Hz is set up on a stretched string of length 210 cm.

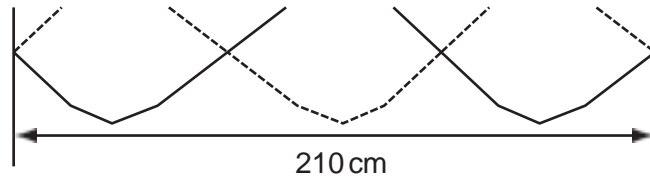

What is the speed of the waves that produce this stationary wave?

- A 56.0 m s^{-1} B 112 m s^{-1} C 5600 m s^{-1} D $11\,200 \text{ m s}^{-1}$

47. T is a microwave transmitter placed at a fixed distance from a flat reflecting surface S.



A small microwave receiver is moved from T towards S and receives signals of alternate maxima and minima of intensity.

The distance between one maximum and the next is 15 mm.

What is the frequency of the microwaves?

- A $1.0 \times 10^7 \text{ Hz}$
 B $2.0 \times 10^7 \text{ Hz}$
 C $1.0 \times 10^{10} \text{ Hz}$
 D $2.0 \times 10^{10} \text{ Hz}$

48. Sound waves, emitted by a small loudspeaker, are reflected by a wall.

The frequency f of the waves is adjusted until a stationary wave is formed with the antinode nearest the wall at a distance x from the wall.

Which expression gives f in terms of x and the speed of sound c ?

- A $f = \frac{4c}{x}$ B $f = \frac{2c}{x}$ C $f = \frac{c}{2x}$ D $f = \frac{c}{4x}$

49. The diagram represents a stationary wave on a stretched string.

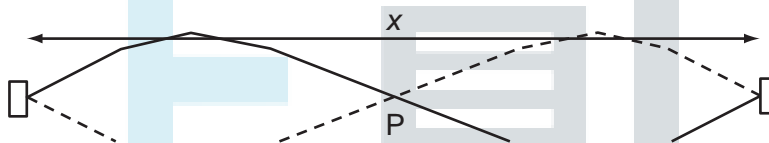

What is represented by point P and by the length x ?

	point P	length x
A	antinode	one wavelength
B	antinode	two wavelengths
C	node	one wavelength
D	node	two wavelengths

50. A stationary longitudinal wave is set up in a pipe.

In the diagrams below, the length of each arrow represents the amplitude of the motion of the airmolecules, and the arrow head shows the direction of motion at a particular instant.

Which diagram shows a stationary wave in which there are two nodes and two antinodes?

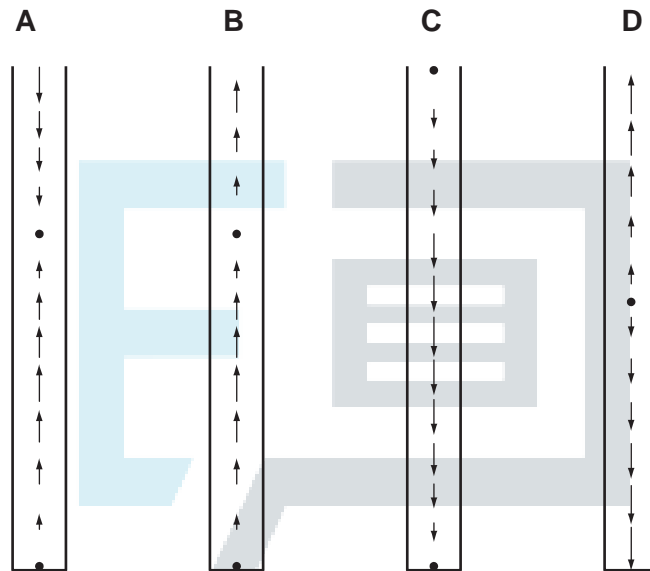

51. Which phenomenon is associated with transverse waves but not longitudinal waves?

- A polarization B reflection C refraction D superposition

52. A displacement-time graph is shown for a particular wave.

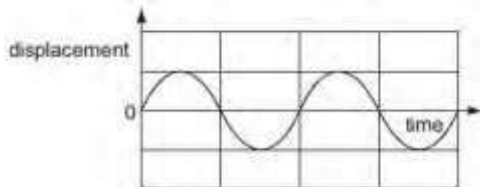

A second wave of similar type has twice the intensity and half the frequency. When drawn on the same axes, what would the second wave look like?

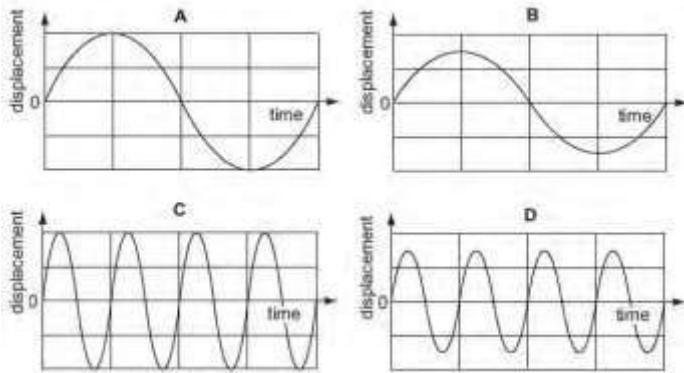

53. The frequency of a certain wave is 500 Hz and its speed is 340 m s^{-1} . What is the phase difference between the motions of two points on the wave 0.17 m apart?

- A $\frac{\pi}{4}$ rad B $\frac{\pi}{2}$ rad C $\frac{3\pi}{4}$ rad D π rad

54. Where, in a standing wave, do the vibrations of the medium occur?

- A only at the nodes C at all points between the nodes
 B only at the antinodes D at all points between the antinodes

55. Monochromatic light is incident on a diffraction grating and a diffraction pattern is observed. Which line of the table gives the effect of replacing the grating with one that has more lines per metre?

	number of orders of diffraction visible	angle between first and second orders of diffraction
A	decreases	decreases
B	decreases	increases
C	increases	decreases
D	increases	increases

56. The graph represents a sinusoidal wave in the sea, travelling at a speed of 8.0 m s^{-1} , at one instant of time. The maximum speed of the oscillating particles in the wave is $2\pi af$, where a is the amplitude and f is the frequency.

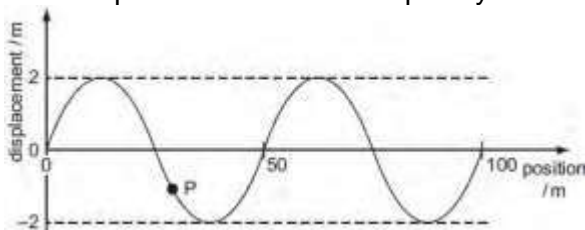

An object P of mass $2.0 \times 10^{-3} \text{ kg}$ floats on the surface.

What is the maximum kinetic energy of P due to the wave? Assume that its motion is vertical.

- A 0.026 mJ B 4.0 mJ C 39 mJ D 64 mJ

57. Monochromatic light illuminates two narrow parallel slits. The interference pattern which results is observed on a screen some distance beyond the slits.

Which change increases the separation between the dark lines of the interference pattern?

- A decreasing the distance between the screen and the slits

- B increasing the distance between the slits
- C using monochromatic light of higher frequency
- D using monochromatic light of longer wavelength

58. A narrow beam of monochromatic light is incident normally on a diffraction grating. Third-order diffracted beams are formed at angles of 45° to the original direction. What is the highest order of diffracted beam produced by this grating?
 A 3rd B 4th C 5th D 6th

June 08

59. The graph shows how the height of a water surface at a point in a harbour varies with time t as waves pass the point.

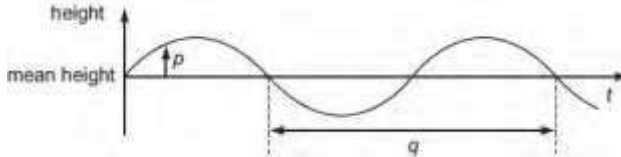

What are p and q ?

	p	q
A	displacement	wavelength
B	displacement	period
C	amplitude	wavelength
D	amplitude	period

60. The intensity I of a sound at a point P is inversely proportional to the square of the distance x of P from the source of the sound. That is

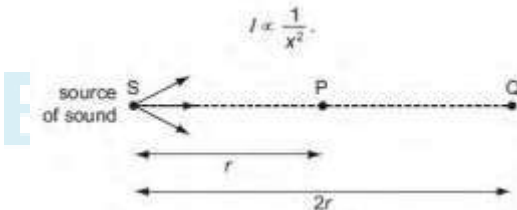

Air molecules at P , a distance r from S , oscillate with amplitude $8.0 \mu\text{m}$. Point Q is situated a distance $2r$ from S . What is the amplitude of oscillation of air molecules at Q ?

- A $1.4 \mu\text{m}$ B $2.0 \mu\text{m}$ C $2.8 \mu\text{m}$ D $4.0 \mu\text{m}$