



EXAM PAPERS PRACTICE

GCSE OCR Math J560

Transformation

Enlargement

Question Paper

*"We will help you to
achieve A Star "*



Question 1

Enlarge shape **J** using scale factor $\times 2$ and centre $(0, 2)$.
Label your image **K**.

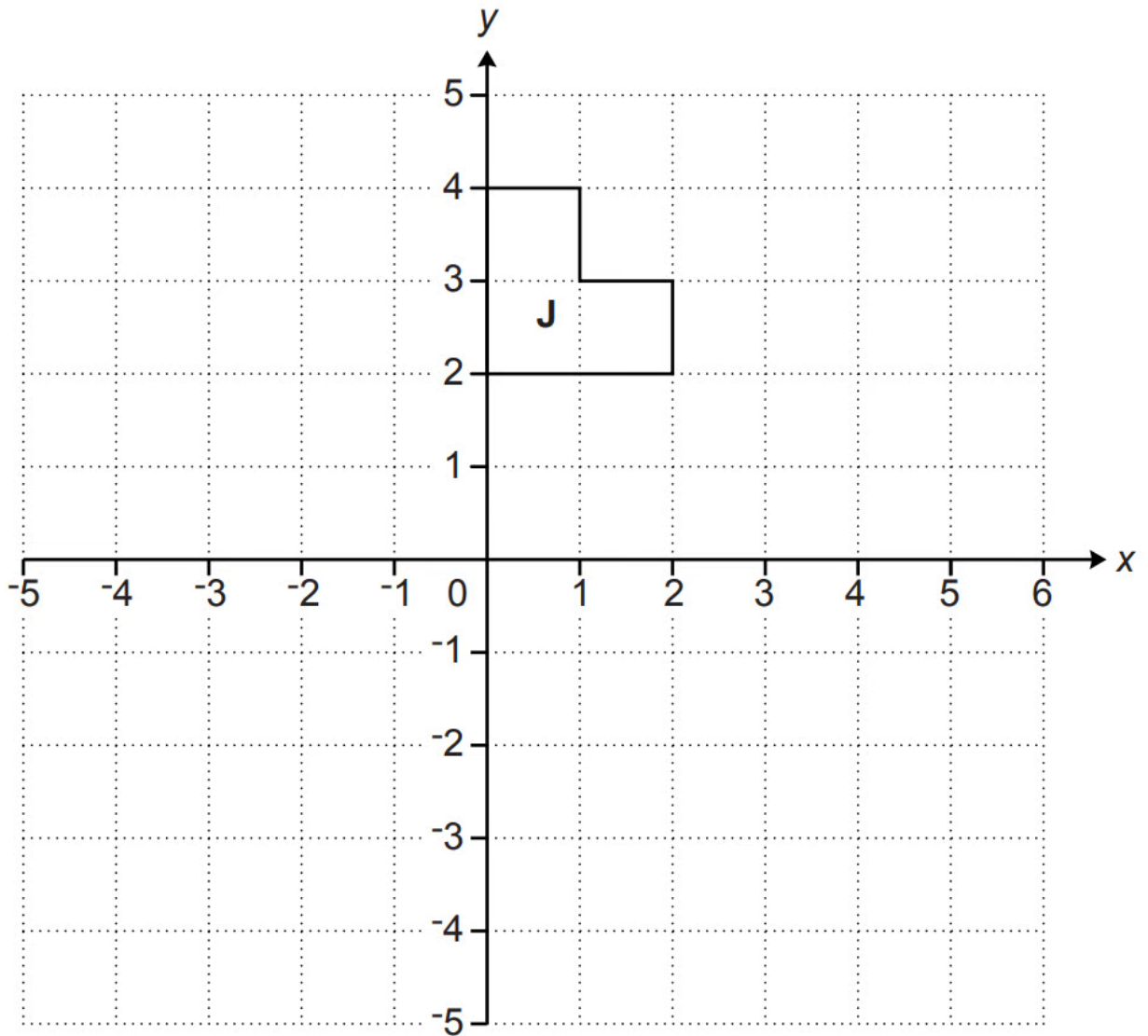

[3 marks]



Question 2

Shape **S** is shown on the grid.

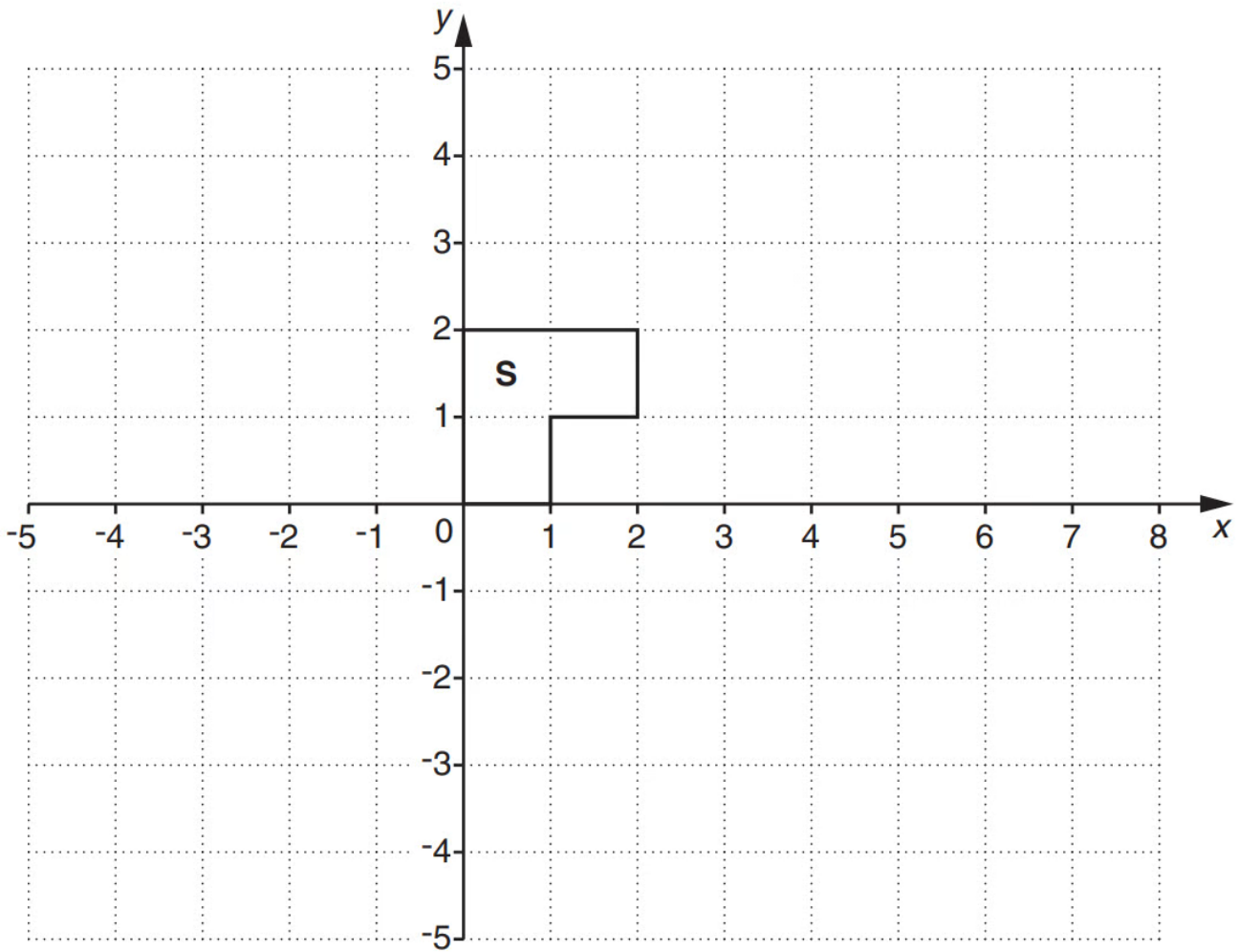

Enlarge shape **S** with scale factor -2 and centre $(0, 0)$.

Label your image **E**.

[2 marks]



Question 3

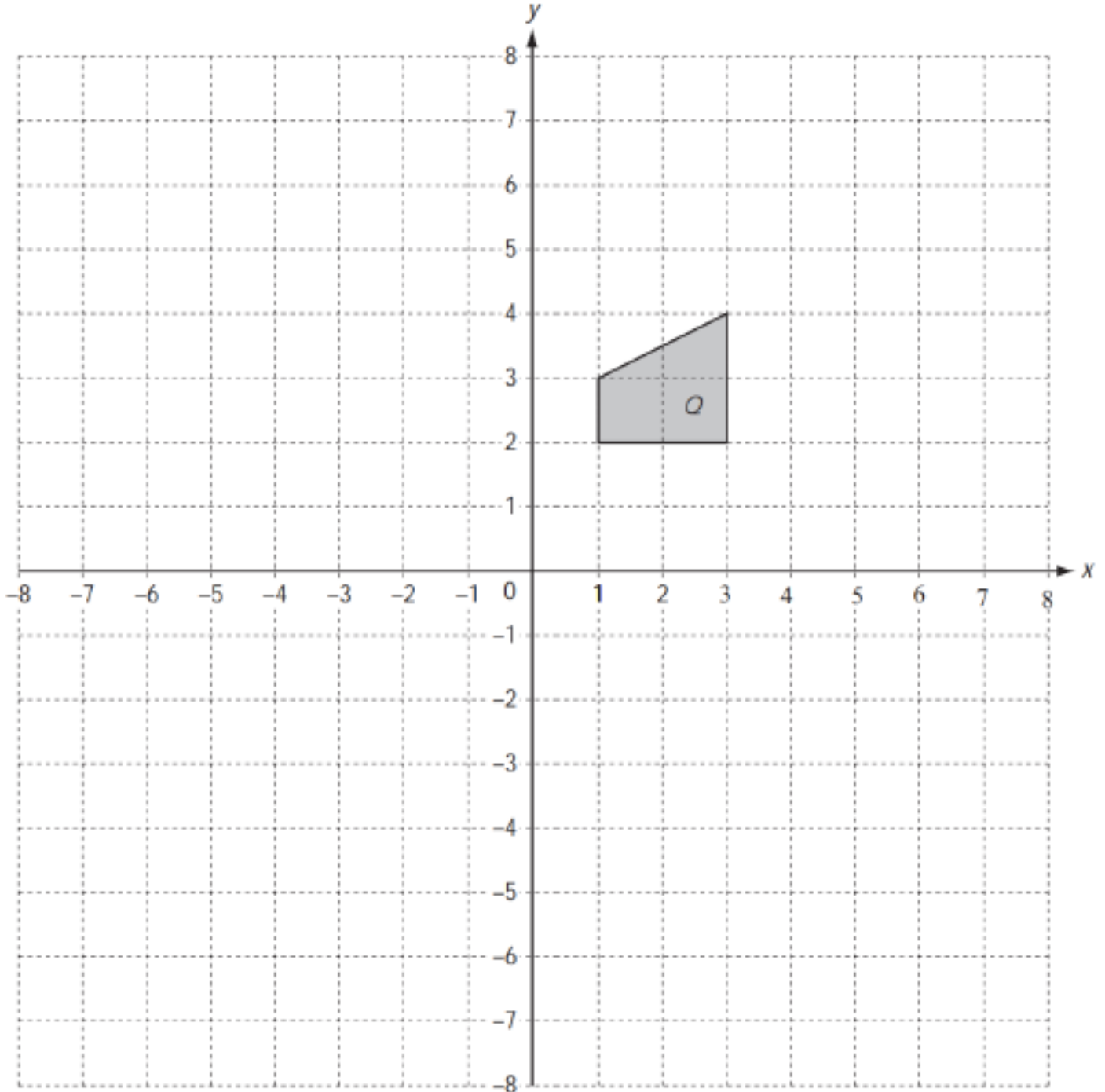

Draw the enlargement of shape Q , centre $(0, 0)$, scale factor -2 .

[2 marks]



Question 4

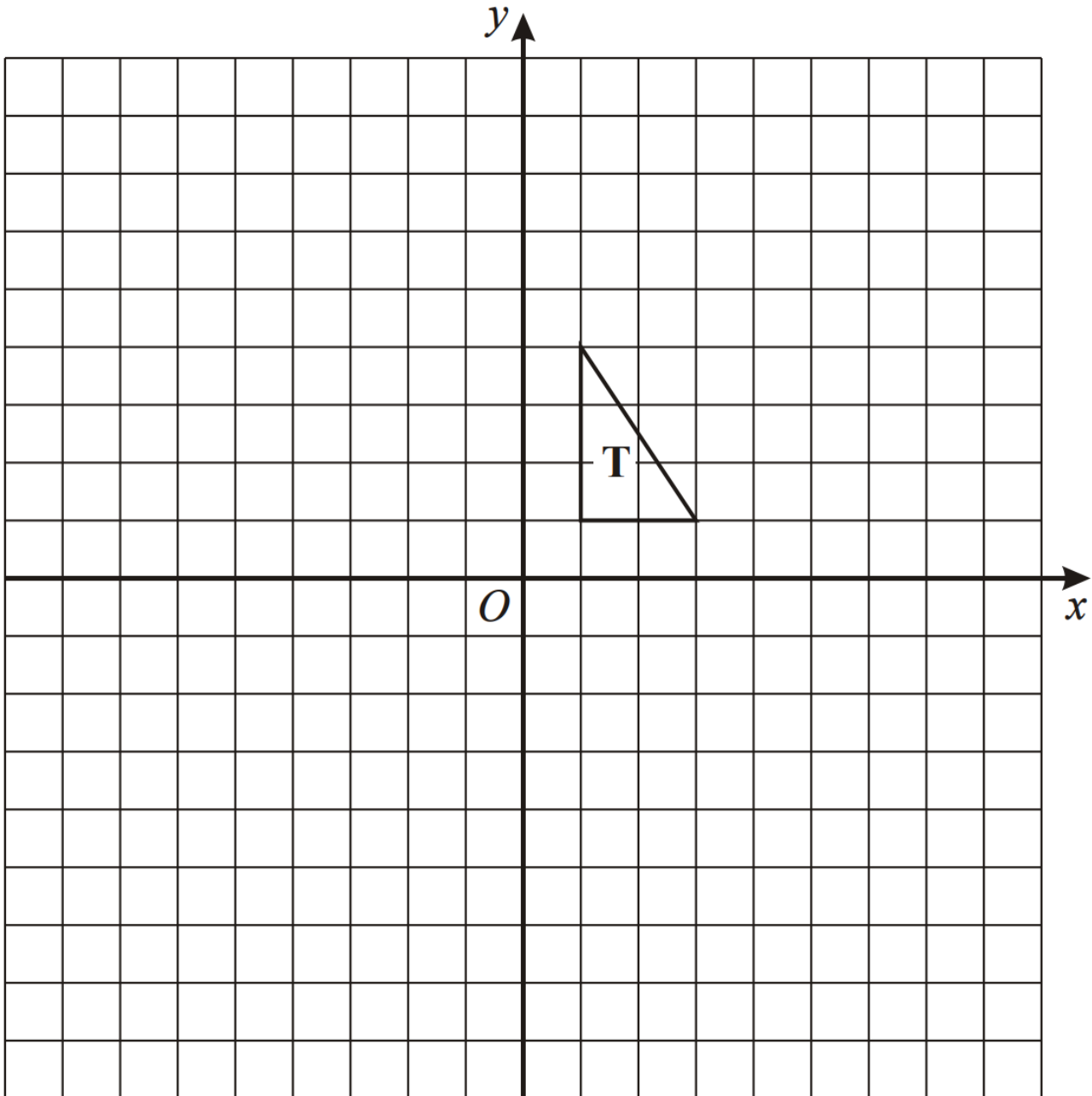

Enlarge triangle **T**, scale factor -2 , centre O .

[2 marks]



Question 5

Triangles **J** and **L** are drawn on the grid below.

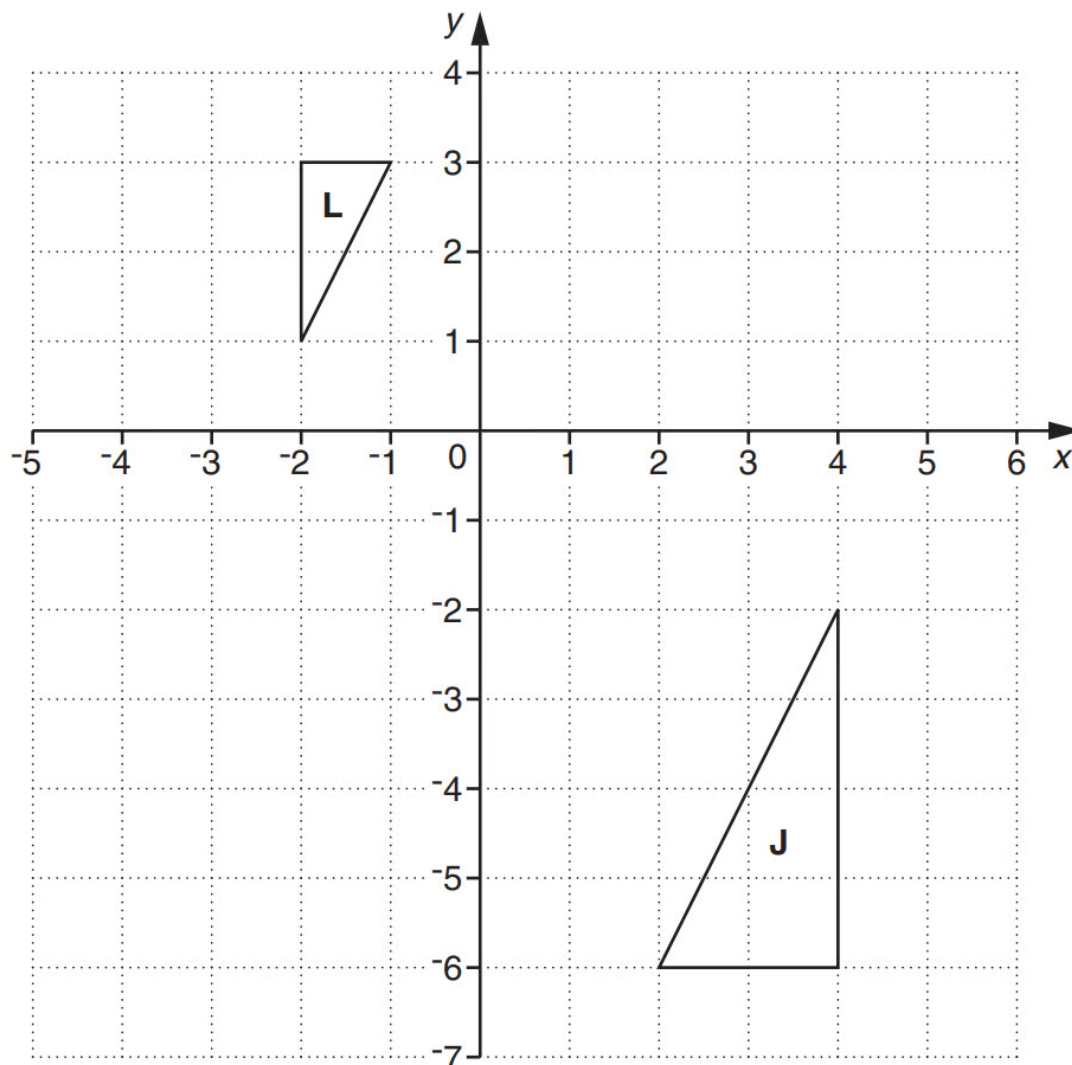

What is the scale factor of the enlargement that maps triangle **L** onto triangle **J**?

[1 mark]



Question 6

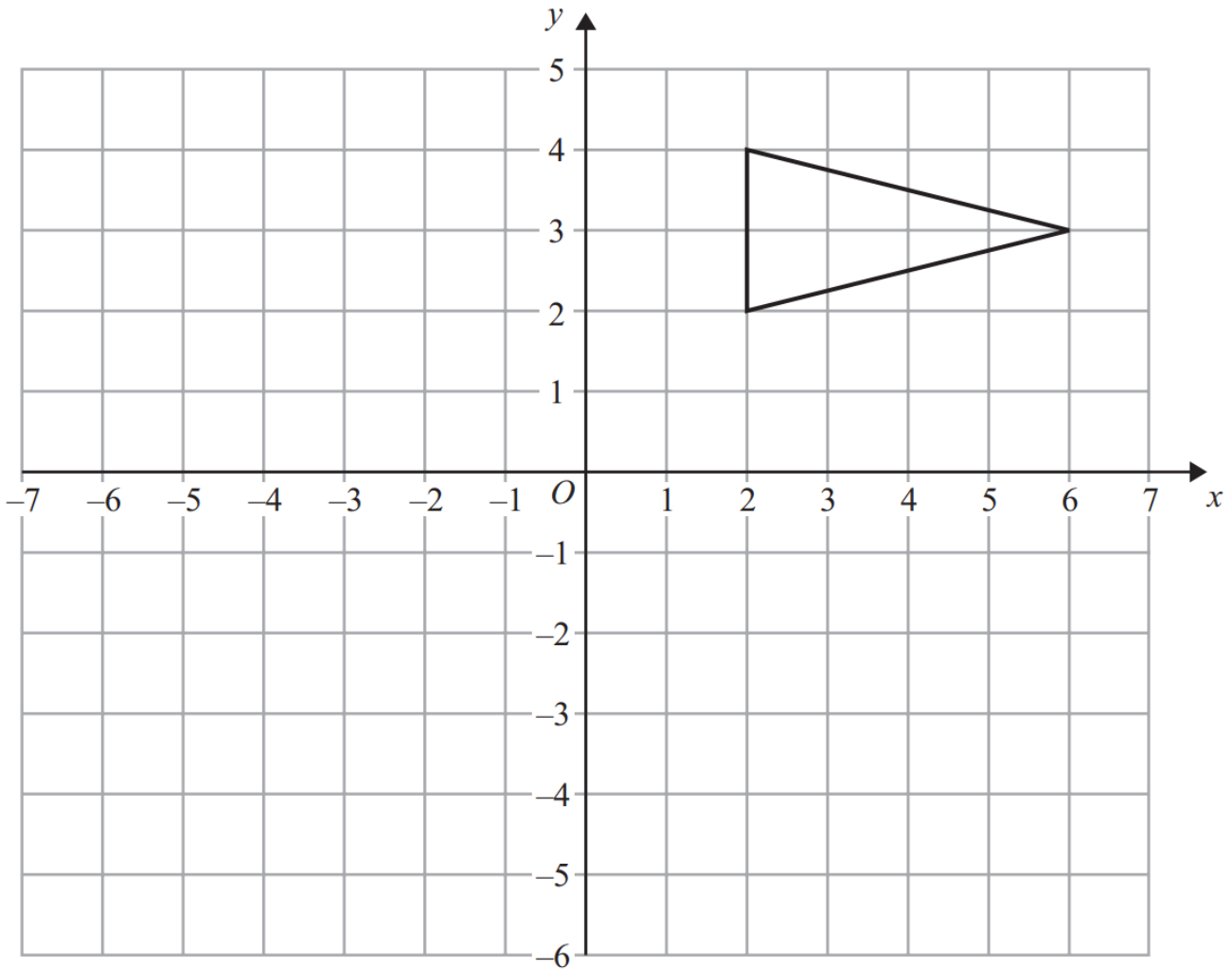

On the grid, enlarge the triangle by scale factor $-\frac{1}{2}$, centre $(0, -2)$.

[2 marks]



Question 7

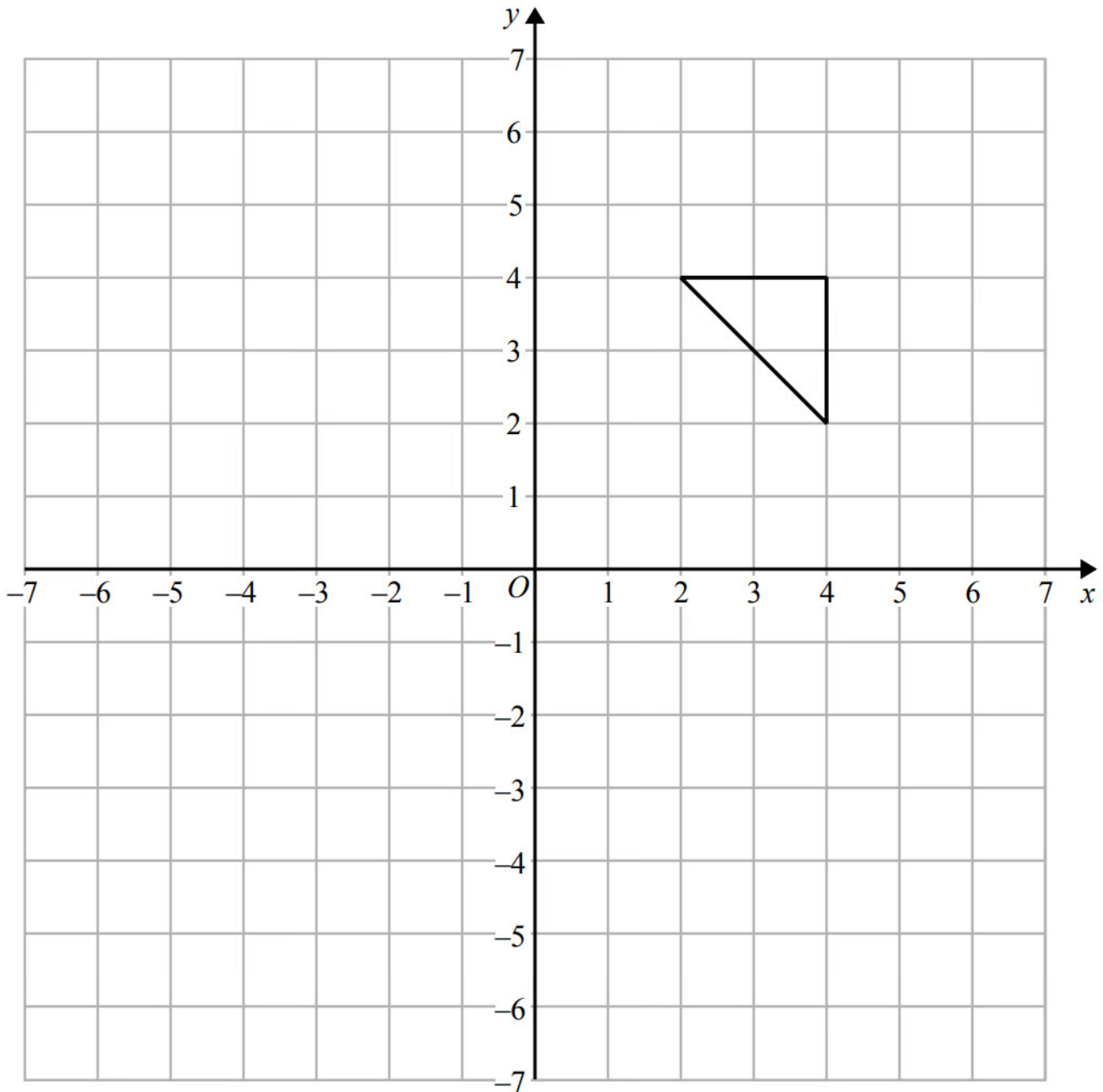

On the grid, enlarge the triangle by scale factor $-1\frac{1}{2}$, centre (0, 2)

[2 marks]



Question 8

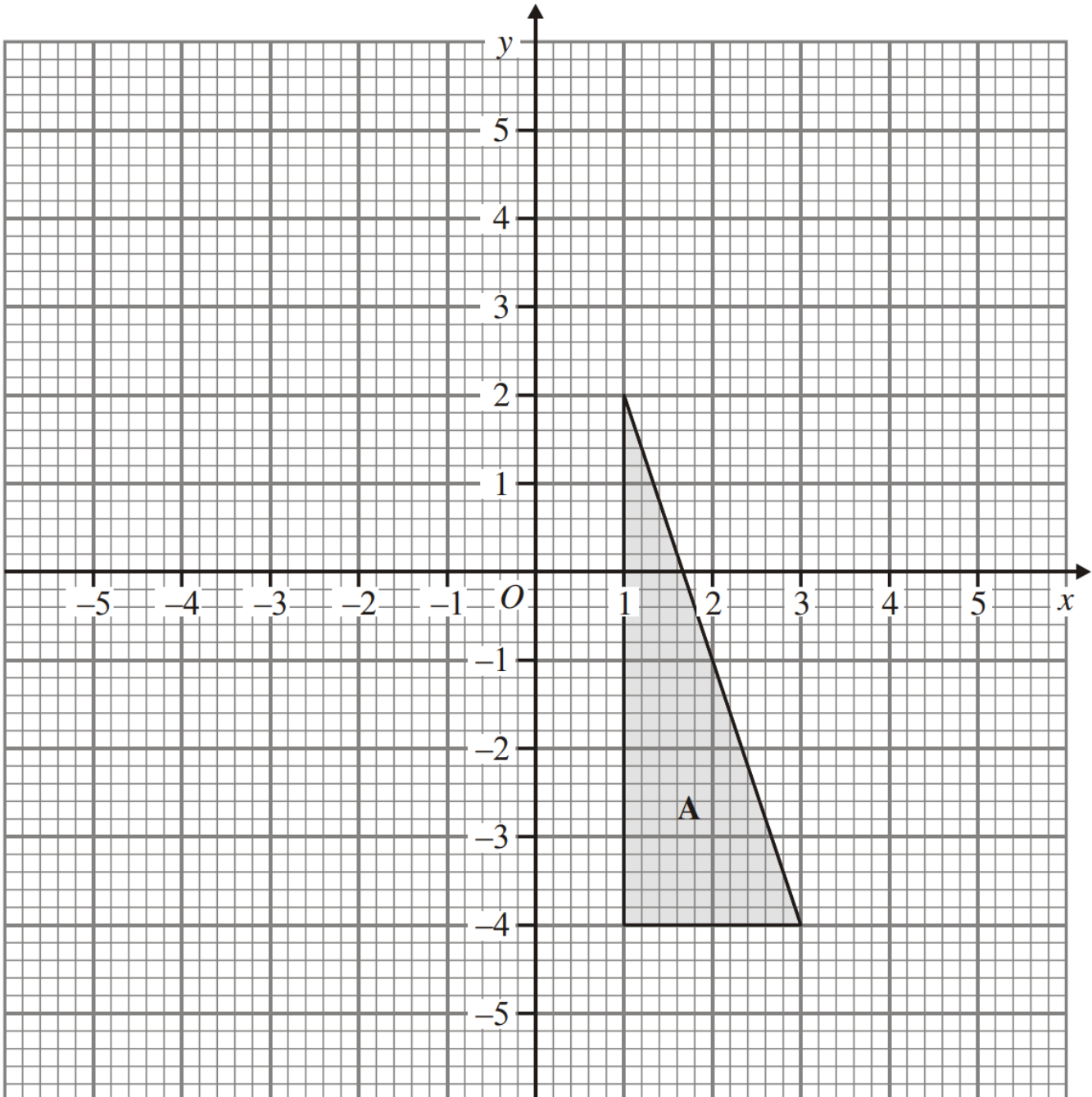

Enlarge triangle **A** by scale factor $-\frac{1}{2}$, centre $(-1, -2)$.

Label your triangle **B**.

[3 marks]



Question 9

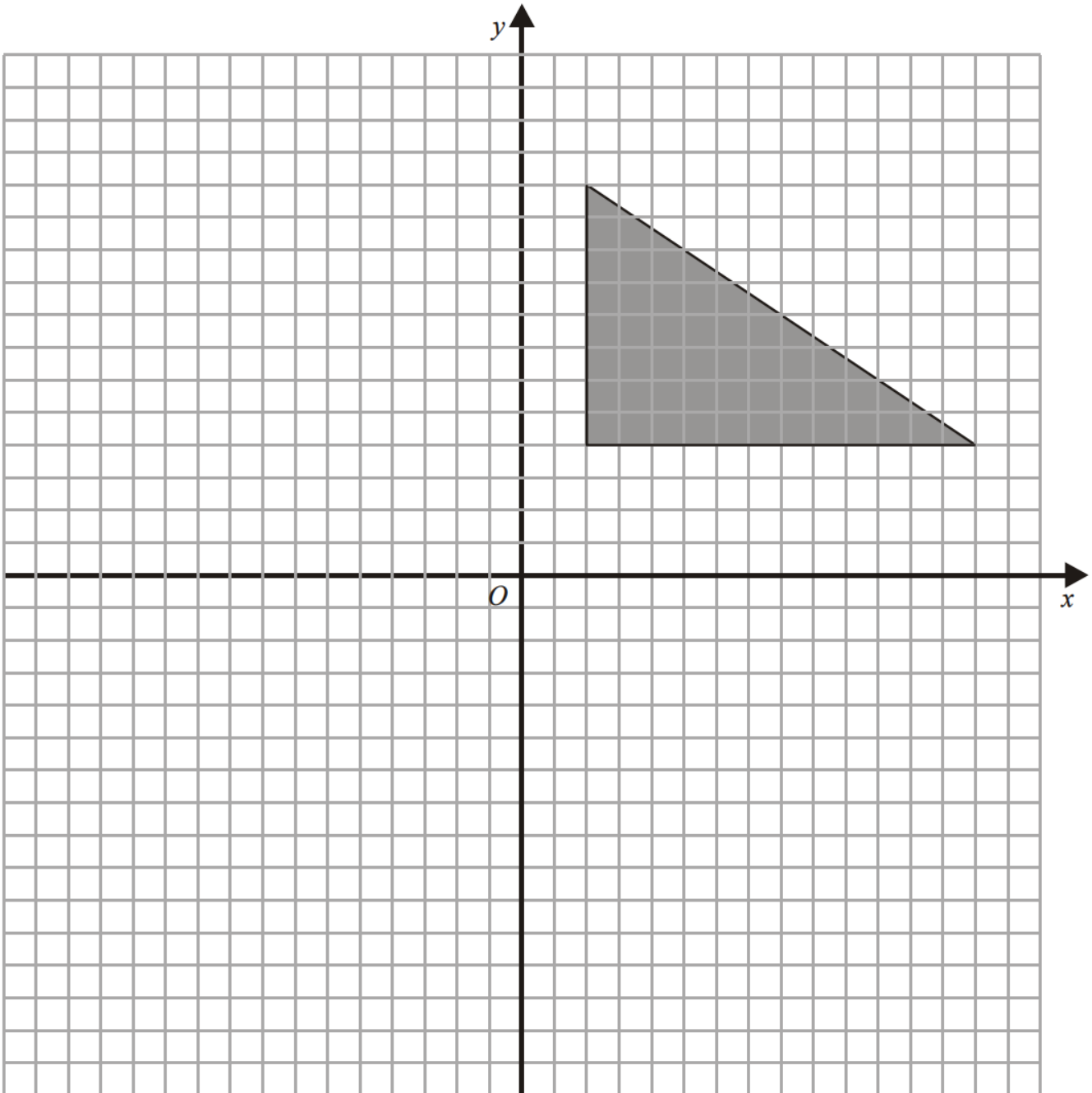

Enlarge the triangle by a scale factor of $-\frac{1}{2}$, centre O

[2 marks]



Question 10

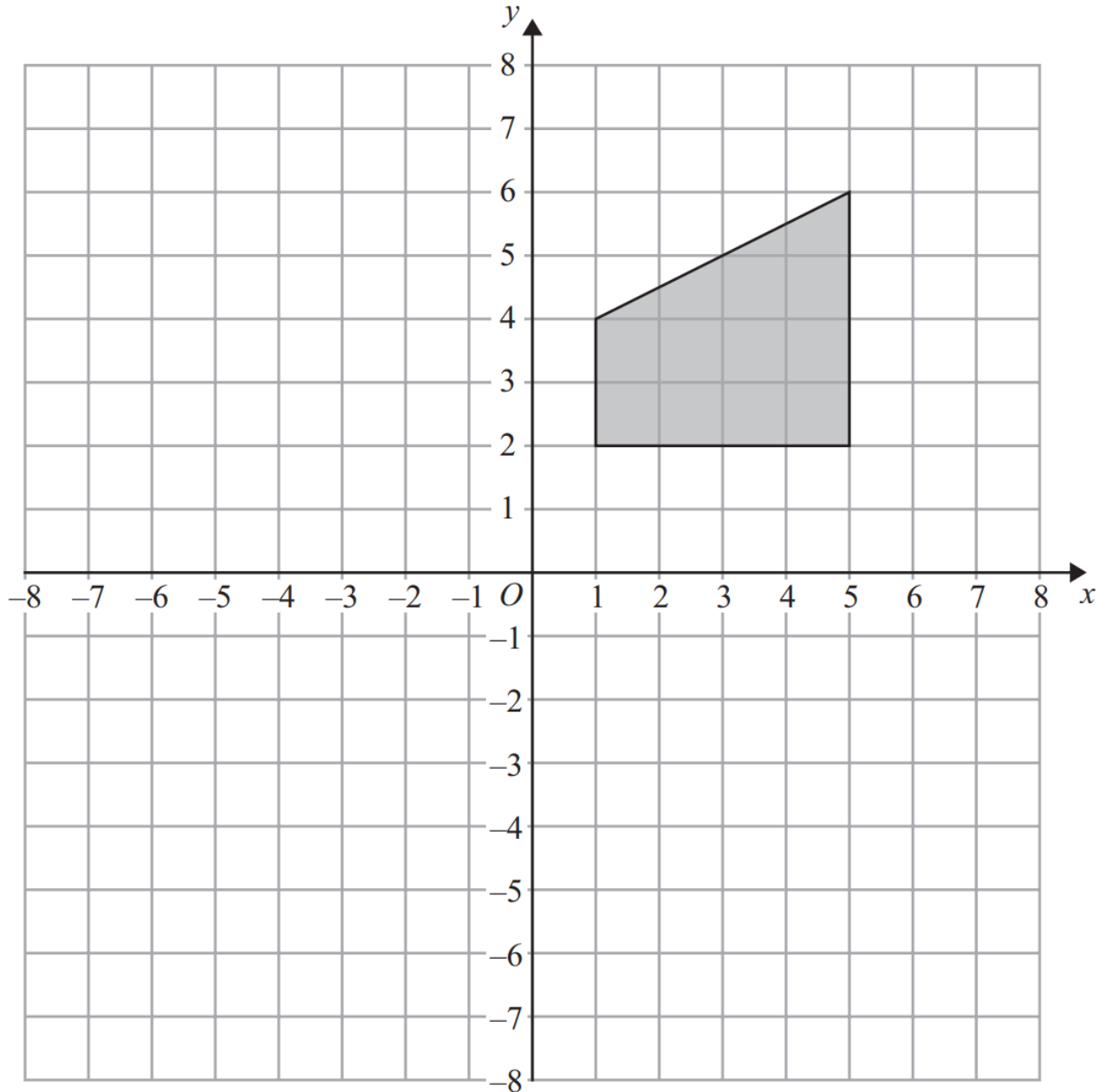

Enlarge the shaded shape by scale factor $-\frac{1}{2}$ with centre $(-1, -2)$.

[3 marks]



Question 11

(b) Describe fully the single transformation that will map shape **B** onto shape **A**.

[1 mark]

Question 12

The triangle ABC is to be enlarged, using E as the centre, to give the triangle PQR . The line PQ is the image of the line BA .

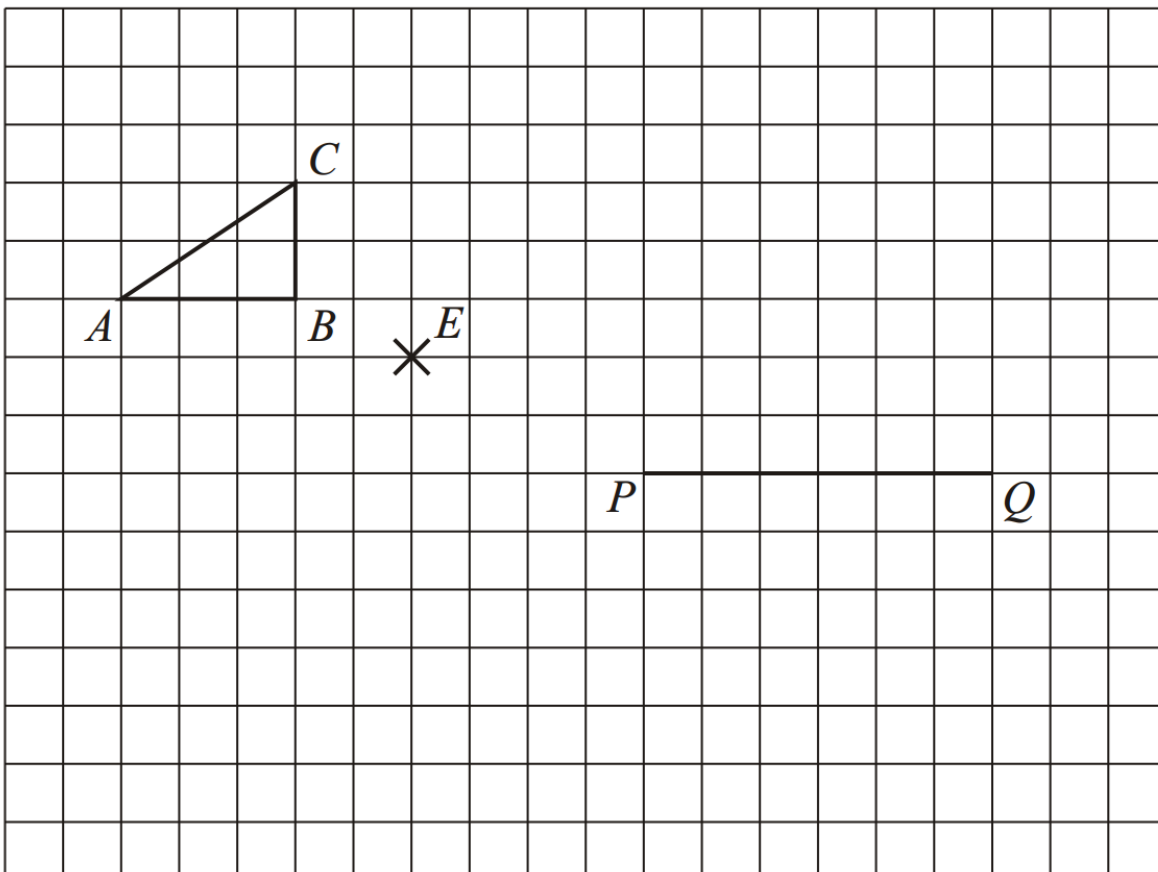

(b) Complete the triangle PQR .

[1 mark]



Question 13

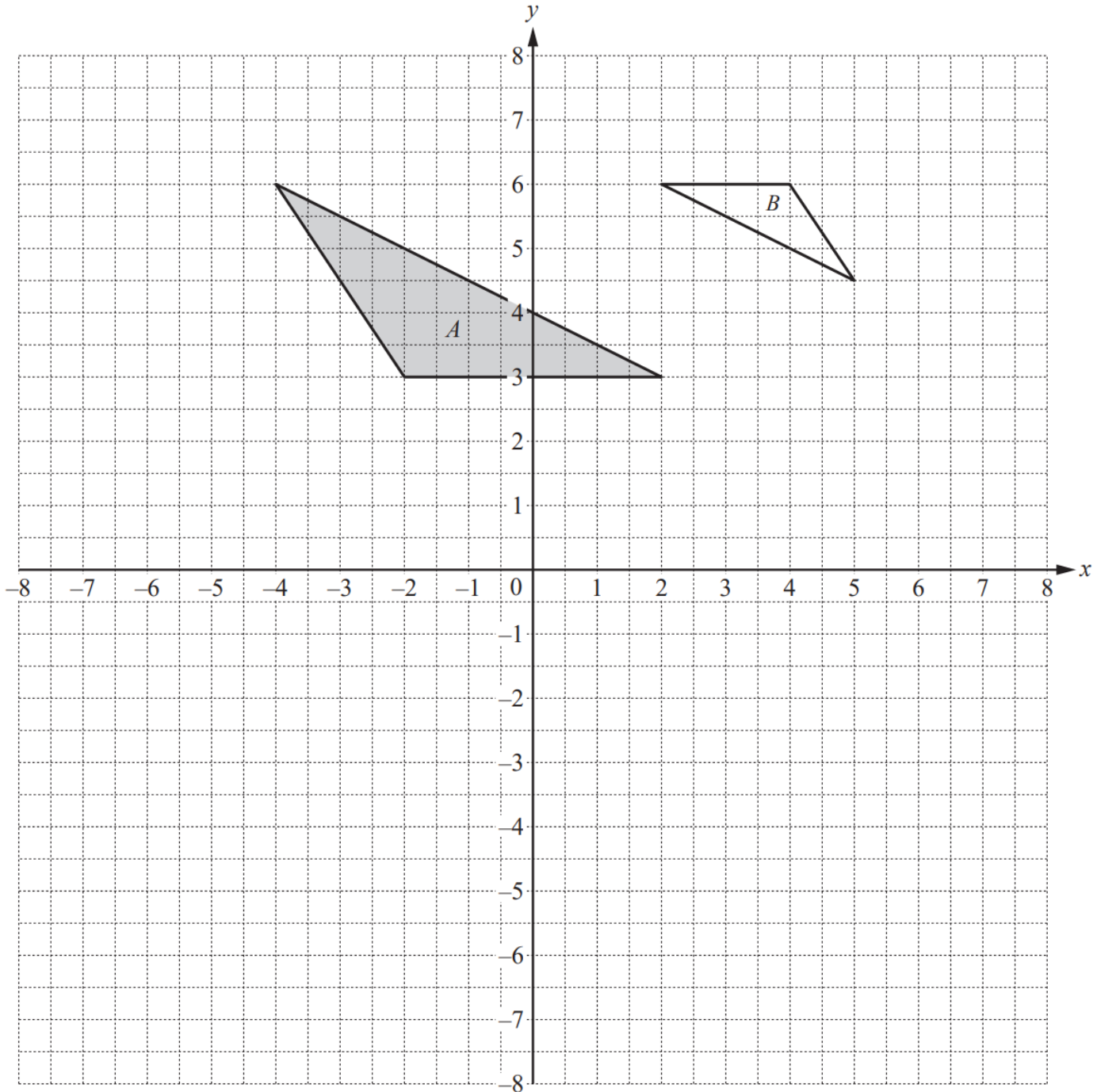

Describe fully the **single** transformation that maps triangle *A* onto triangle *B*.

[3 marks]



Question 14

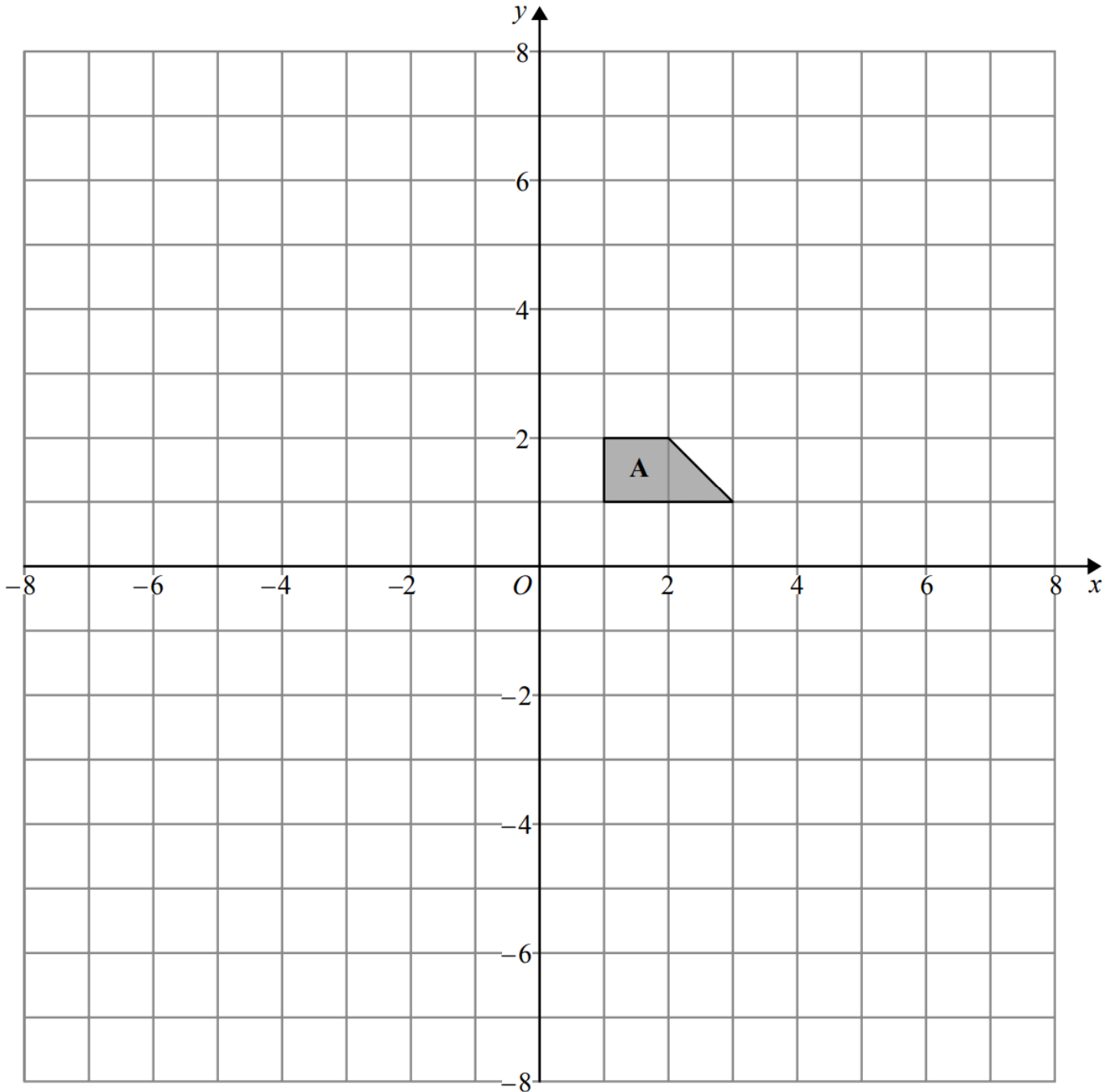

- (a) Enlarge shape **A** by scale factor -2 , centre $(0, 0)$
Label your image **B**.

[2 marks]



Question 15

The triangle ABC is to be enlarged, using E as the centre, to give the triangle PQR . The line PQ is the image of the line BA .

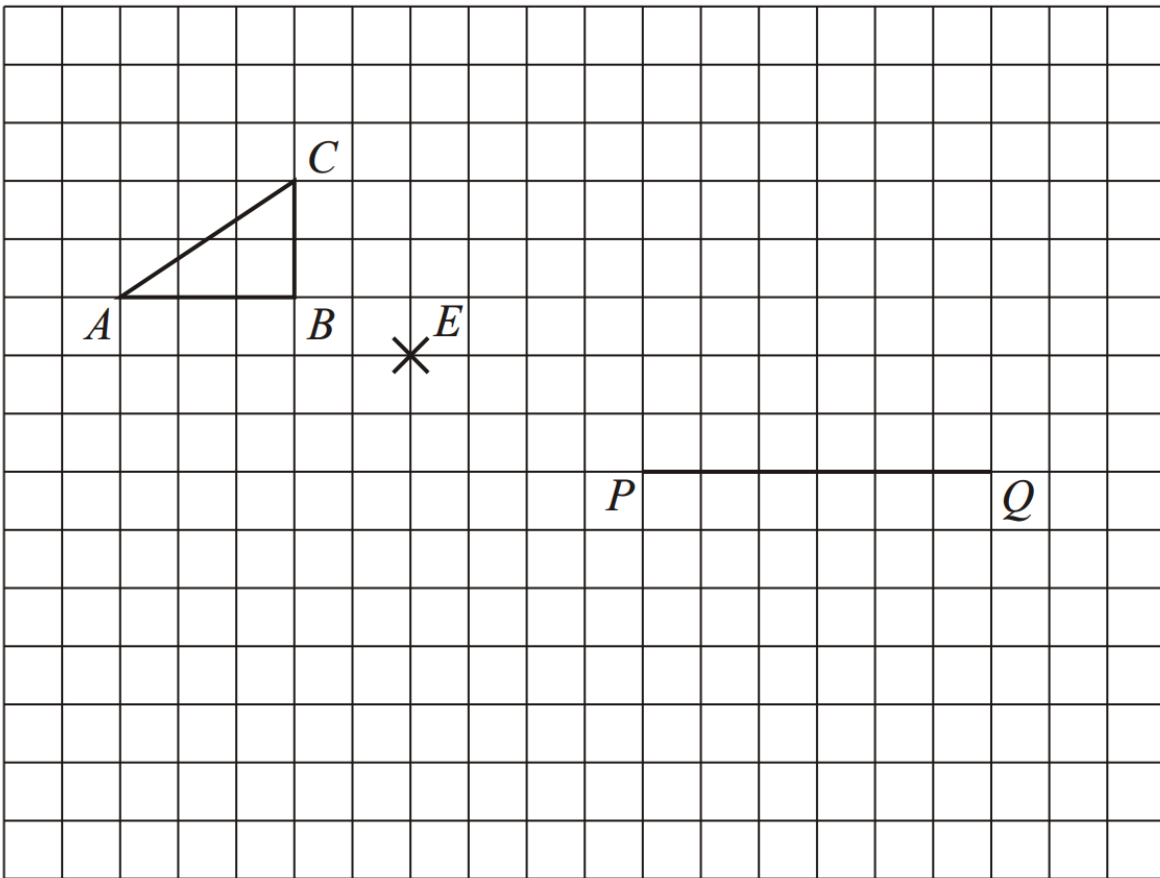

(a) Write down the scale factor of the enlargement.

[1 mark]