



**Exam Papers Practice**

Boost your performance and confidence with these topic-based exam questions

Practice questions created by actual examiners and assessment experts

Detailed mark schemes

Suitable for all boards

Designed to test your ability and thoroughly prepare you

## **Gas Exchange**



# **IB Biology - Revision Notes**

---

[www.exampaperspractice.co.uk](http://www.exampaperspractice.co.uk)

## Gas Exchange in Organisms

### Gas Exchange in Organisms

- **Cellular respiration** is a process occurring in all living cells that **releases energy** in the form of ATP
  - This energy is released when substrate molecules such as glucose is **oxidised**
  - Organisms use this energy to perform important life functions such as nutrition and excretion
- **Aerobic respiration** requires **oxygen** to occur and it produces carbon dioxide as a waste product
  - Living organisms **acquire this oxygen** from their environment and **release carbon dioxide** back into their surroundings
- The process by which these gases are exchanged between living organisms and their environment is called **gas exchange**
  - This includes oxygen uptake and the release of carbon dioxide by organisms
  - In plants, carbon dioxide will be absorbed and oxygen released during the day as a result of photosynthesis
- Gas exchange takes place by the process of diffusion, the rate of which is determined by the following factors:
  - Size of the respiratory surface - the bigger the surface, the higher the rate of diffusion
  - Concentration gradient
  - Diffusion distance - the shorter the distance, the higher the rate of diffusion
- Small, unicellular organisms such as **amoeba** have a **large surface area compared to the volume** of cytoplasm and a **short diffusion distance**
  - This means that the rate of diffusion is sufficient to supply the organism with enough oxygen to function

Single Celled Organism Diffusion Diagram

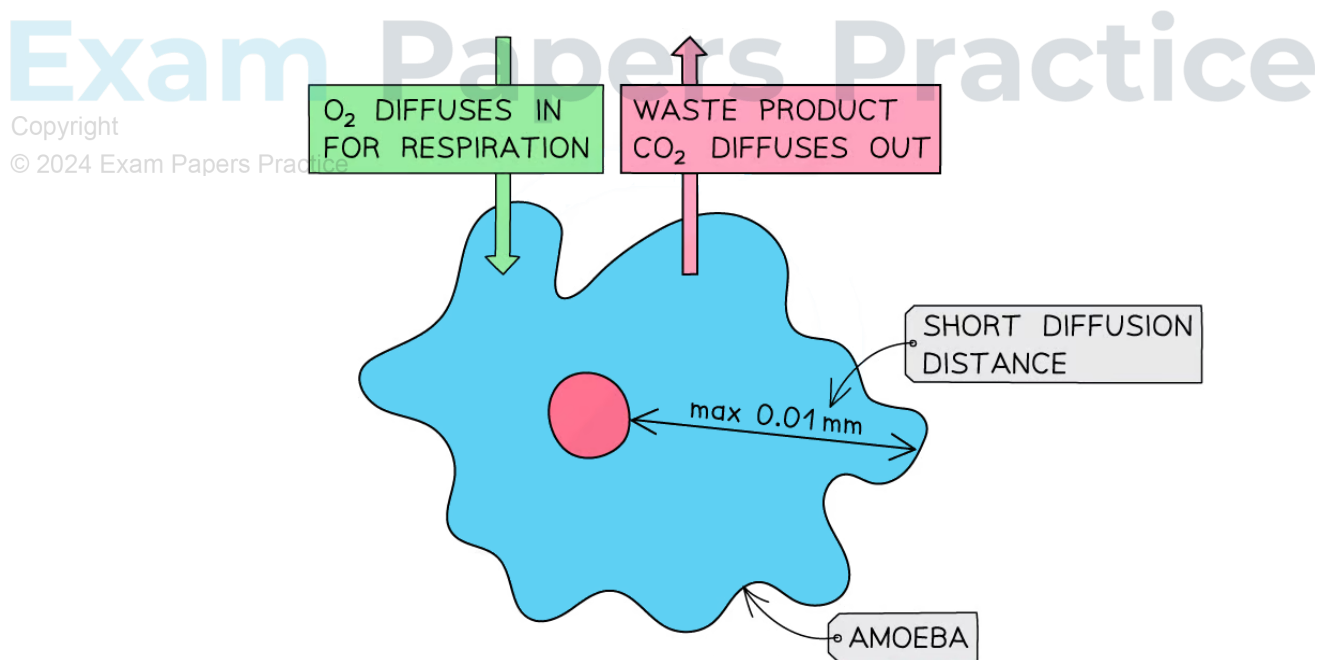

*Small, unicellular organisms have a large surface area to volume ratio and a short diffusion distance to allow for effective gas exchange to occur*

## Challenges of gas exchange in organisms

- As an organism increases in size, the challenges of gas exchange become greater
- This is because an **increase in size** will result in a:
  - **Smaller** surface area to volume ratio
  - **Greater** diffusion distance
- Large, multicellular organisms therefore **cannot rely on diffusion alone** to supply every cell with oxygen
  - Another challenge is that the **external surface** of these organisms are designed to provide protection to the tissue underneath and is therefore **not suitable as a respiratory surface**
- The cells of **large, active** organisms will require **more oxygen** than smaller, less active organisms in order to meet their metabolic demands
  - These organisms will require **specialised organs** for gas exchange

### Exam Tip

Make sure that you do not confuse respiration and gas exchange with each other. Respiration is a chemical process occurring in all living cells while gas exchange refers to the diffusion of oxygen and carbon dioxide across a respiratory surface.

## Gas Exchange Surfaces: Properties

- To **maximise the rate of diffusion** of oxygen and carbon dioxide, gas exchange surfaces require certain properties which include:
  - **Permeability** in order for gases to move across the surface
  - **Thin tissue layer** to create a short diffusion distance for oxygen and carbon dioxide
  - Presence of **moisture** so that gases can dissolve
    - This will facilitate the diffusion of gases across a gas exchange surface
  - **Large surface area** so that many gas molecules can diffuse across at the same time

Copyright © 2024 Exam Papers Practice

## Maintaining a Concentration Gradient

- A steep concentration gradient will ensure a **high diffusion rate** across a gas exchange surface
  - In organisms, this will allow the diffusion of oxygen into the body and the diffusion of carbon dioxide out of the body
- These concentration gradients are maintained in the following ways:
  - A **dense network of blood vessels** to provide a large surface area for the diffusion of gases
    - Blood provides a good transport medium for both oxygen and carbon dioxide
  - A **continuous blood flow** in the blood vessels to ensure that oxygen is constantly transported away from the gas exchange surface and carbon dioxide towards them
    - This ensures that oxygen will always diffuse into the blood and carbon dioxide out of the blood in the lungs
  - **Ventilation** with air in lungs and water in gills to bring oxygen close to the gas exchange surface and to remove carbon dioxide



### Alveolus Diagram

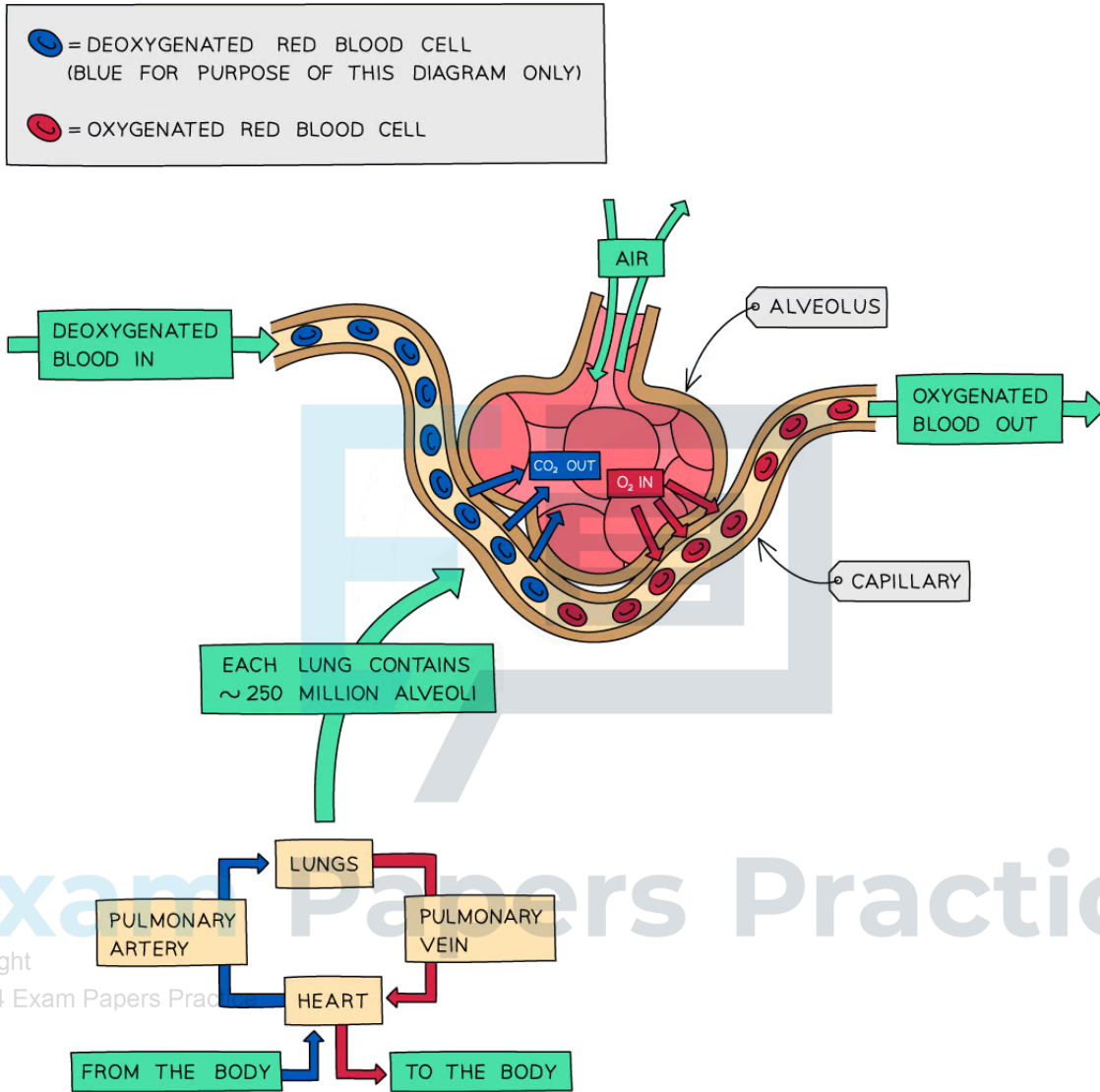

*The alveolus is the gas exchange surface in humans where a concentration gradient for oxygen and carbon dioxide is maintained*



## Mammalian Lungs: Adaptations

### Mammalian Lungs: Adaptations

- Air moves in through the nose and mouth before it is carried to the lungs through the **trachea**
- The **trachea** is a tube supported by **rings of cartilage** which help to support its shape and ensure it stays open while allowing it to move and flex with the body
- The **trachea** divides to form the two **bronchi** (singular bronchus) with walls also strengthened with cartilage and a layer of smooth muscle that can **contract** or **relax** to change the diameter of the airways. Both trachea and bronchi are lined with **ciliated epithelium** to remove particles trapped in mucus that enter the airways
  - One bronchus leads to each lung
- **Bronchioles** branch off the two bronchi to form a network of narrow tubes
  - The walls of the bronchioles are lined with a layer of **smooth muscle** to alter the diameter of the bronchiole tubes
  - This helps to regulate the flow of air into the lungs by dilating when more air is needed and constricting when e.g. an allergen is present
- Groups of alveoli are found at the end of the bronchioles
- Each alveolus is surrounded by an extensive network of **capillaries** to provide a **good blood supply** for maximum gas exchange

Human Gas Exchange System Diagram

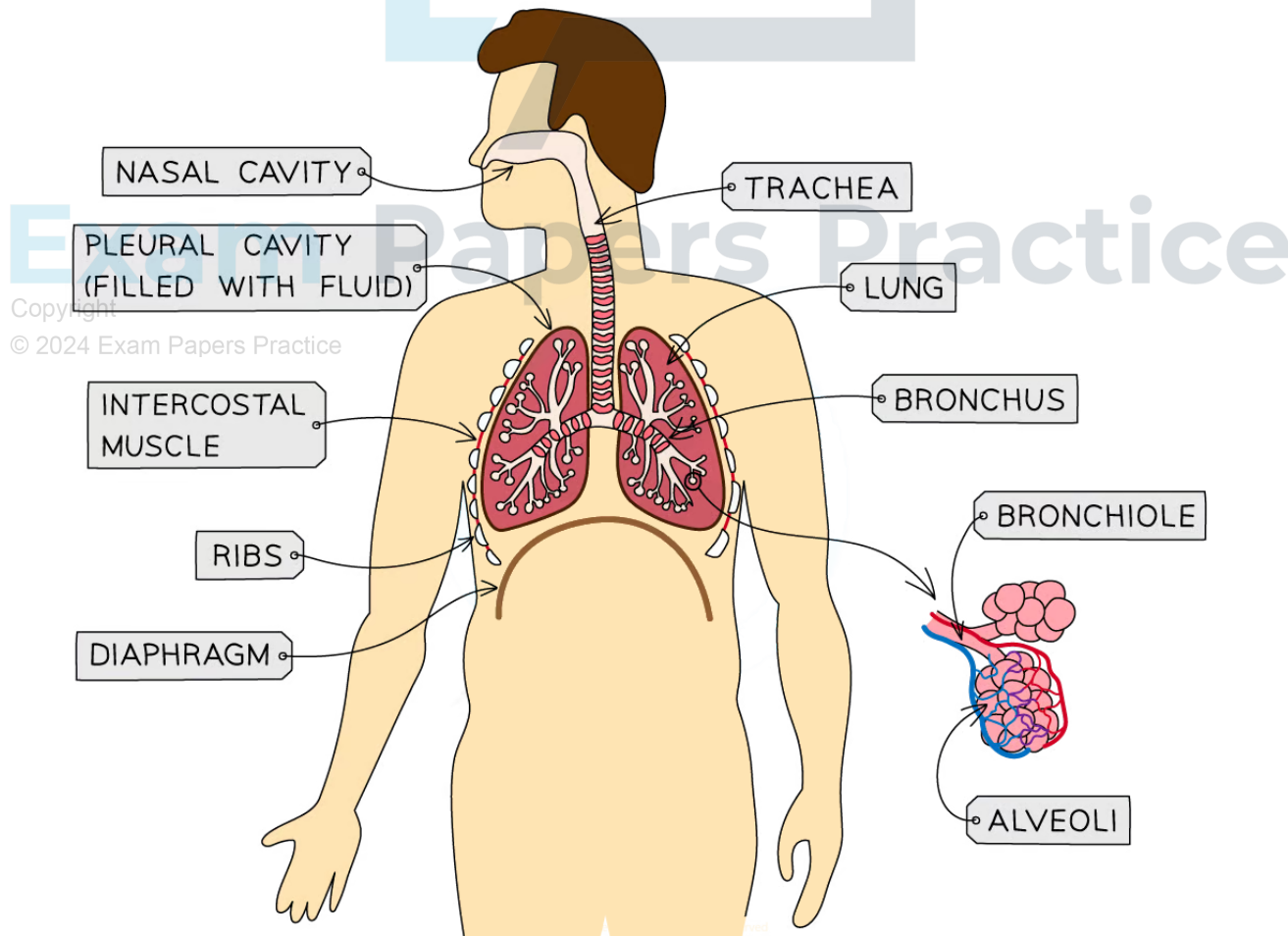

The main structures of the human gas exchange system



## Adaptations of mammalian lungs for gas exchange

- Each mammalian lung is comprised of **many, small alveoli**
  - These provide a **large surface area** for gas exchange
- Alveoli are grouped around the ends of **bronchioles**, which spreads out to form a **branched network** across each lung
  - This ensures an **even distribution** of alveoli throughout the lungs
- The clusters of alveoli are surrounded by an **extensive capillary bed**
  - This provides an **increased surface area** for the diffusion of oxygen and carbon dioxide between the alveoli and blood
  - Deoxygenated blood enters the capillary beds from a branch of the pulmonary artery while oxygenated blood leaves the capillary beds via a branch of the pulmonary vein
    - This **maintains the concentration gradient** of oxygen and carbon dioxide between the alveoli and blood
- Cells of the alveolar wall secrete a substance called **surfactant** which lowers the surface tension in the alveoli
  - This prevents the alveoli from collapsing and sticking together during expiration

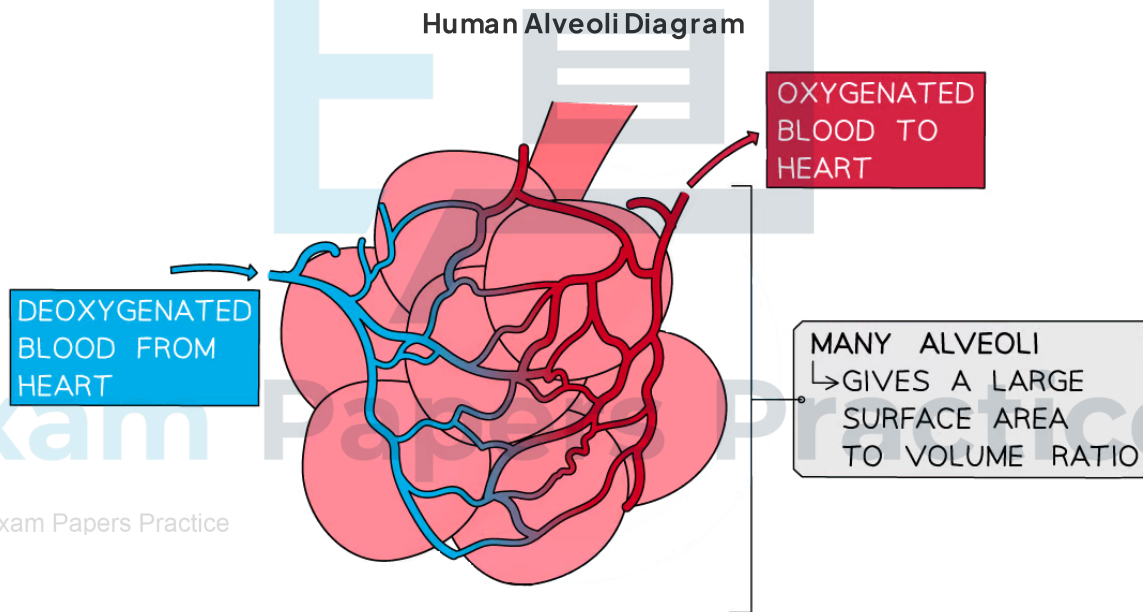

Copyright

© 2024 Exam Papers Practice

*Many, small alveoli and an extensive capillary network are examples of how the mammalian lung is adapted for gas exchange*

### Exam Tip

Make sure of the terminology that you use here; do not confuse the alveolar wall with a cell wall. The **alveolar wall** is a single layer of epithelial cells that forms the alveoli, while a **cell wall** is a rigid structure that surrounds a plant cell.



## Mechanism of Ventilation

### Ventilation: Mechanism

- Ventilation is essential for the effective **exchange of gases** in the lungs
  - It replaces older air in the lungs with fresh air from the external environment
  - This helps to maintain the concentration gradient of oxygen and carbon dioxide between the alveoli and blood
- Ventilation involves **inspiration** (breathing in) and **expiration** (breathing out)

### Inspiration

- The breathing-in, or **inspiration**, process causes the **volume of the chest to increase** and the **air pressure to decrease** until it is **lower than the atmospheric pressure**
  - When gas is in a large volume container that allows the gas particles to spread out, the pressure exerted by the gas on the walls of the container is low
- As a result, air moves **down the pressure gradient** and rushes into the lungs
  - A gas will always move down a pressure gradient from an area of high pressure to an area of low pressure
- The inspiration process
  - The diaphragm **contracts** and **flattens**, increasing chest volume
  - In addition to the flattening of the diaphragm the **external** intercostal muscles **contract**, causing the ribcage to move **upwards** and **outwards**; this also increases chest volume

INHALATION

BREATHING IN

- EXTERNAL INTERCOSTAL MUSCLES CONTRACT
- RIBCAGE MOVES UP AND OUT
- DIAPHRAGM CONTRACTS AND FLATTENS
- VOLUME OF THORAX INCREASES
- PRESSURE INSIDE THORAX DECREASES
- AIR IS DRAWN IN

Copyright © 2024 Exam Papers Practice

*The process of inspiration*

**Expiration**

- Breathing out, or **expiration**, occurs mostly due to the recoil of the lungs after they have been stretched by the inspiration process, and is therefore a mainly **passive process**

- **Volume of the chest decreases** and **pressure increases**, causing air to be forced out down its **pressure gradient**
  - When gas is in a low volume container it is compressed, causing the gas particles to exert more pressure on the walls of the container
- The passive expiration process
  - External intercostal muscles **relax**, allowing the ribcage to move **down** and **in**
  - Diaphragm **relaxes** and becomes **dome-shaped**
  - The **recoil** of **elastic fibres** in the alveoli walls reduces the volume of the lungs
- The expiration process can be active when there is a need to expel excess air from the lungs e.g. when blowing out a candle
- The active expiration process
  - **Internal** intercostal muscles **contract** to pull the ribs **down** and **in**
  - **Abdominal muscles contract** to push organs upwards against the diaphragm, decreasing the volume of the chest cavity
  - This causes **forced exhalation**

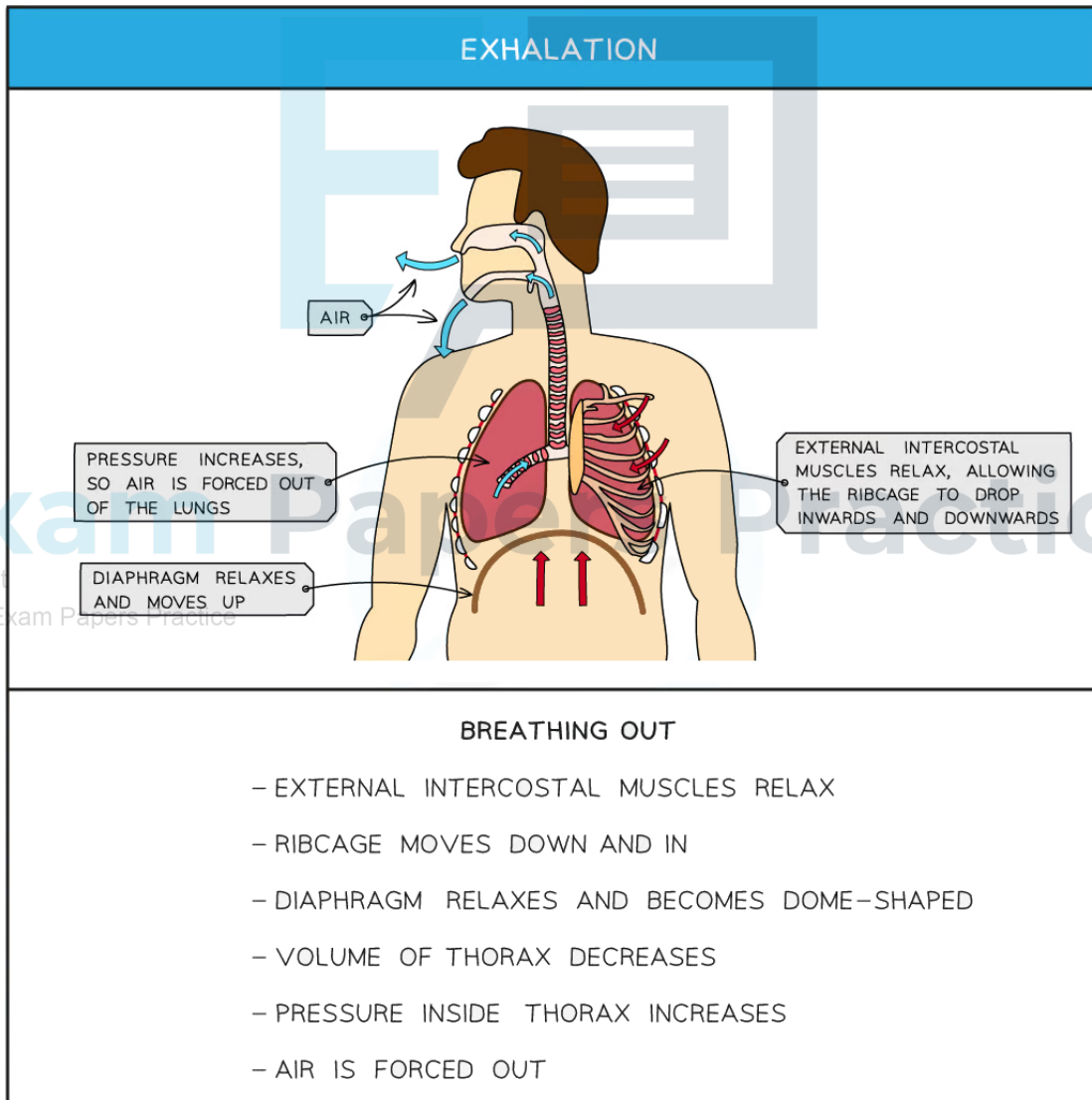

*The process of passive expiration*

## Measuring Lung Volumes: Skills

### Measuring Lung Volumes

- It is possible to investigate the effect of exercise on ventilation using an apparatus called a **spirometer**
  - It contains a chamber filled with water which is covered by a hinged plastic lid
  - The person partaking in the experiment breathes through a mouthpiece which is connected to the spirometer chamber
  - The plastic lid moves up and down as breathing occurs
- The spirometer chamber could be filled with either **air or oxygen**
  - When filled with air, it can be used to determine **lung capacity** in different conditions
  - When filled with oxygen and soda lime (for absorbing carbon dioxide), it can measure **oxygen consumption** in different conditions
- Spirometer traces** are created by:
  - Drawing a line on a revolving drum as the lid moves
  - A computer which draws a graph of the results
- Several **measurements can be made** using spirometer traces such as:
  - Ventilation rate
  - Tidal volume
  - Reserve volumes during inspiration and expiration
  - Vital capacity

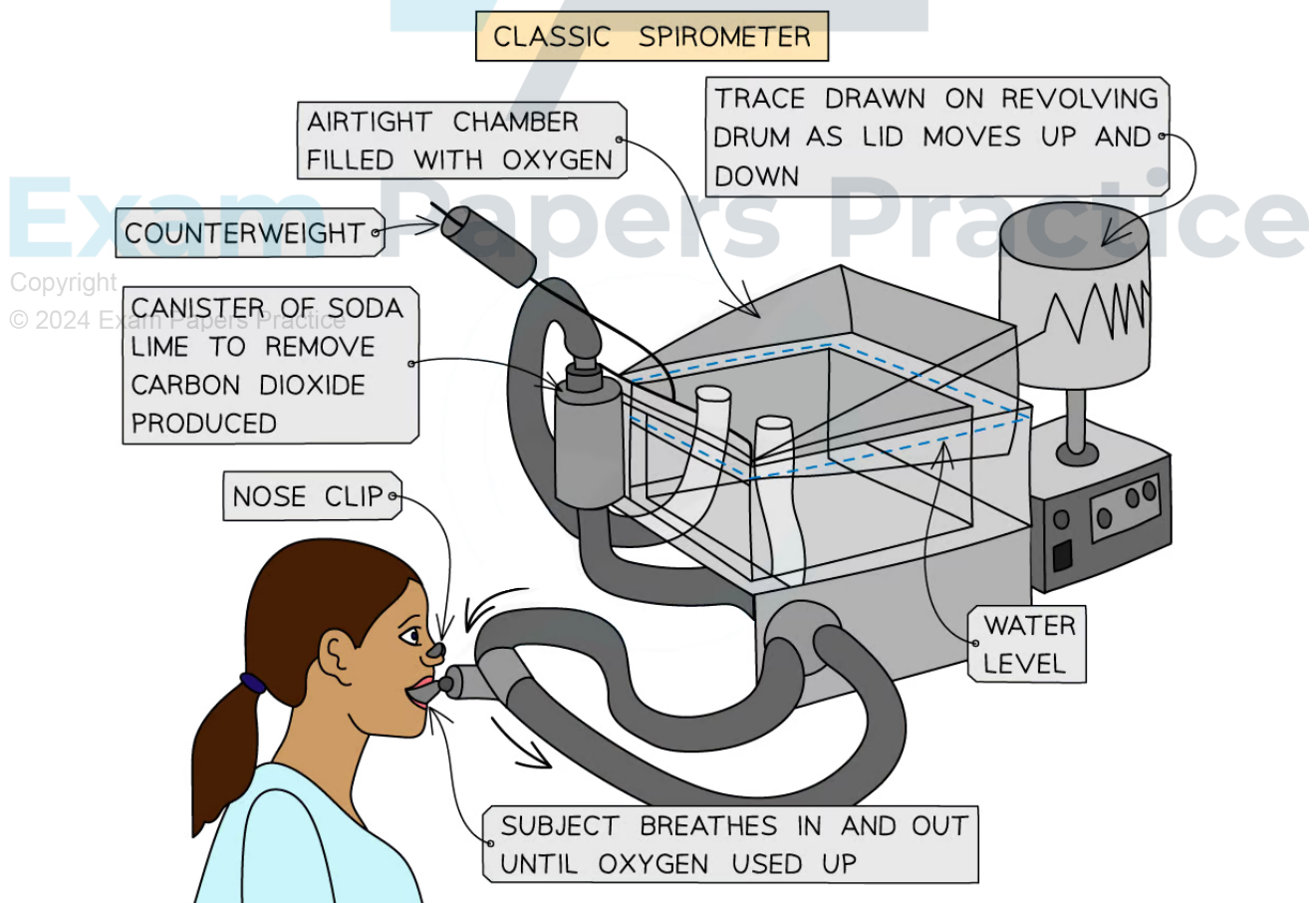

*A classic spirometer can be used to investigate ventilation*

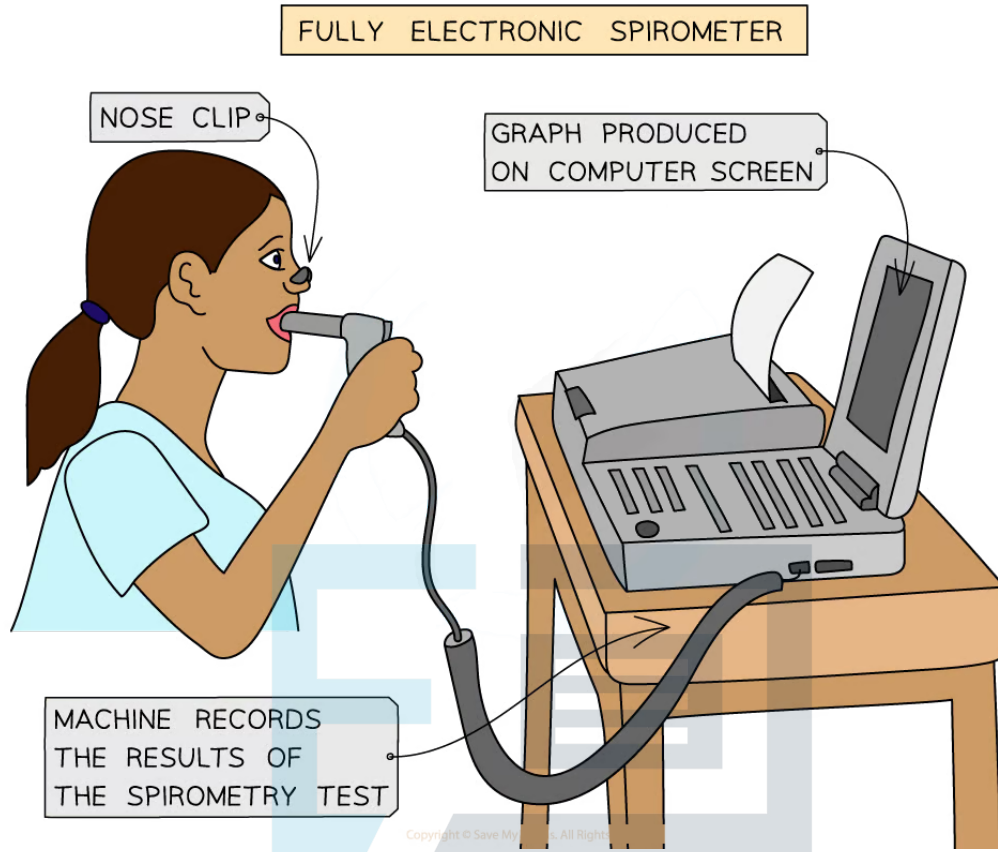

*Using a spirometer to monitor ventilation can also be carried out with an electric spirometer*

### Analysis of spirometer trace

- The effect of exercise on ventilation can be seen in the spirometer trace below

# Exam Papers Practice

Copyright

© 2024 Exam Papers Practice

## Tidal volume

- The **tidal volume** is the volume of air inhaled and exhaled during normal breathing
  - Exercise will lead to an increase in the tidal volume as more air is moved in and out of the lungs
  - We do have the potential to take extra deep breaths
    - The maximum volume of air that can enter the lungs during inspiration is known as the **maximum inspiratory level**
  - Similarly, the maximum volume of air that can be exhaled during expiration is known as the **maximum expiratory level**

## Inspiratory and expiratory reserve volumes

- The **reserve volumes** of the lungs refer to the extra volume of air that can be inhaled or exhaled when taking an extra deep breath and are determined as follows:
  - The difference between the maximum inspiratory level and tidal volume is called the **inspiratory reserve volume**
  - The difference between the maximum expiratory level and tidal volume is called the **expiratory reserve volume**

## Vital capacity

- The **vital capacity (VC)** refers to the total amount of air exhaled after taking a deep breath
  - This can be calculated by adding the **tidal volume (TV)**, **inspiratory reserve volume (IRV)** and **expiratory reserve volume (ERV)** together

$$VC = TV + IRV + ERV$$

## Ventilation rate

- The **ventilation rate** can be determined by counting the number of inhalations or exhalations per minute
  - Exercise will cause an increase in the ventilation rate as you will be taking more breaths per minute

Copyright

© 2024 Exam Papers Practice





## Gas Exchange in Plants

### Leaf Adaptations for Gas Exchange

- Gas exchange in plants occur through the leaf
- The leaf contains the following tissues:
  - **Epidermal tissue** forming the outer boundary of the leaf
  - **Mesophyll tissue** that make up the bulk of internal structure of the leaf
  - **Vascular tissue** which transports substances between the leaf and the rest of the plant

#### Epidermis

- This is formed by a **single layer** of tightly packed cells
  - The leaf has an upper and lower epidermis which protects the inner parts of the leaf
- The lower epidermis contains tiny pores called **stomata** (singular stoma)
  - Each stoma is surrounded by **two guard cells** which controls the opening and closure of the pore
    - When water moves into the guard cells they become turgid and change shape which opens the stomata
    - They become flaccid when water is lost and this causes the stomata to close
  - Stomata are the structures through which **gas exchange** occur in a leaf
    - They allow for the diffusion of oxygen and carbon dioxide into and out of the leaf
- The epidermis is often covered by a waxy layer called the **cuticle**
  - This forms an impermeable barrier

#### Mesophyll tissue

- These are formed by **parenchyma cells** which contain **chloroplasts**
  - This is where photosynthesis occurs in the leaf
- Two types of mesophyll tissue are found in the leaf:
  - **Palisade mesophyll** forms a layer beneath the upper epidermis and contain many chloroplasts for maximum photosynthesis
  - **Spongy mesophyll** contains large air spaces between the cells for gas exchange to occur

#### Vascular tissue

- Vascular tissue is arranged in **vascular bundles** and is responsible for the transport of substances around the plant
  - Vascular bundles form the **veins** in leaves
  - **Xylem** transports **water** and mineral ions from the roots to the leaves
  - **Phloem** transports the **products of photosynthesis** from the leaves to other parts of the plant

### Structure of a Leaf Diagram

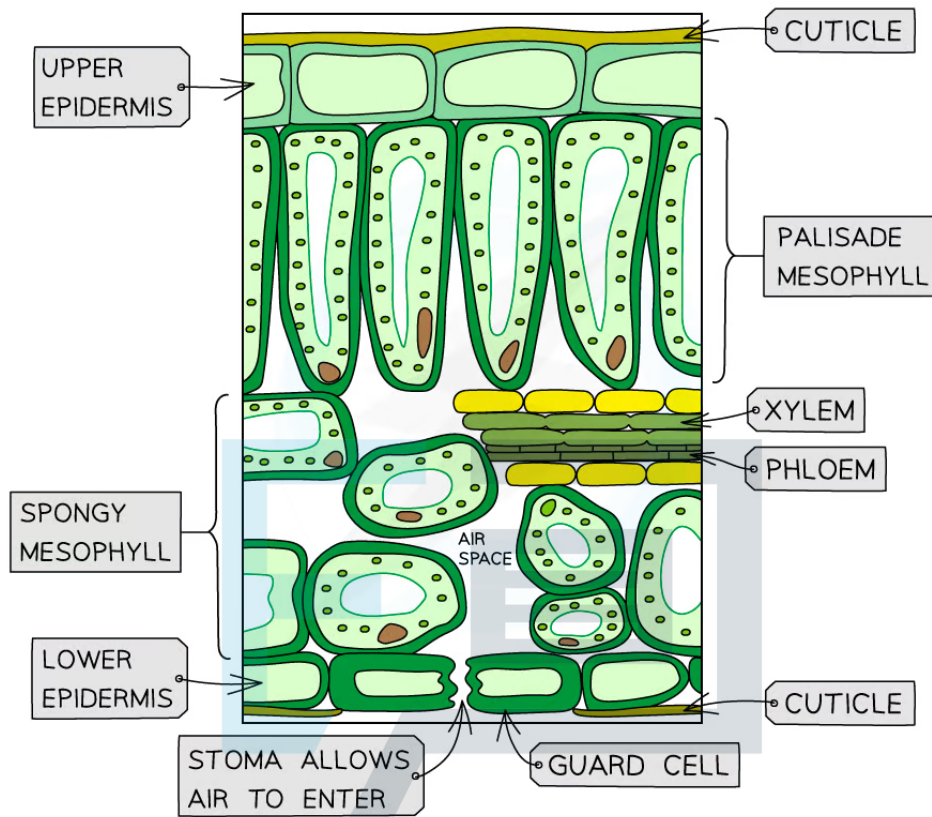

*The structure of a leaf has distinct layers each with their own function*

### Adaptations for gas exchange

Copyright © 2024 Exam Papers Practice  
 The leaf has several adaptations that facilitate gas exchange

#### Leaf Adaptations for Gas Exchange Table

Adaptation	Function
<b>Waxy cuticle</b>	Prevents gases and water vapour from leaving through the epidermis so that gas exchange must occur through stomata. This allows gas exchange and water loss to be controlled
<b>Epidermis</b>	Contain stomata for gas exchange. Most stomata are found in the lower epidermis where the temperature is lower. This reduces water loss
<b>Air spaces</b>	Maintains a concentration gradient of gases between the air



	and spongy mesophyll cells by allowing movement of gases
<b>Spongy mesophyll</b>	Increases the surface area for gas exchange
<b>Guard cells</b>	Control gas exchange and water loss by opening or closing stomata
<b>Veins</b>	Xylem vessels bring water to the leaf which is required for photosynthesis and transpiration. Photosynthesis requires carbon dioxide to diffuse into the leaf while transpiration involves the loss of water vapour

## Transpiration: Consequence of Gas Exchange

- The majority of photosynthesis takes place in the **leaves** of plants
  - Some plants are able to carry out photosynthesis in the cells of their stems
- During photosynthesis, **carbon dioxide is taken in by the leaf and oxygen is released**
  - The **pores in the epidermis of the leaf** through which this gas exchange takes place are known as stomata (singular stoma)
  - The stomata need to be open all the time in order for **gas exchange, and therefore photosynthesis, to continue**
- The problem for plants is that as the stomata open to allow gas exchange to occur, **water in the form of water vapour is also lost through the stomata**
  - This water loss is known as **transpiration**
  - Most plants can use cells called **guard cells to close their stomata** in order to **reduce water loss**, but this will also reduce gas exchange and therefore their rate of photosynthesis
  - **Transpiration is the inevitable consequence of gas exchange in the leaf**
- There are some **advantages** to the process of transpiration
  - It provides a means of **cooling** the plant via **evaporation**
  - The transpiration stream is helpful in the **uptake of mineral ions**
  - The turgor pressure of the cells, due to the presence of water as it moves up the plant, provides **support** to the leaves and to the stems of non-woody plants
    - Leaves with high turgor pressure do not wilt and therefore have an increased surface area for photosynthesis

### Transpiration in the Leaf Diagram

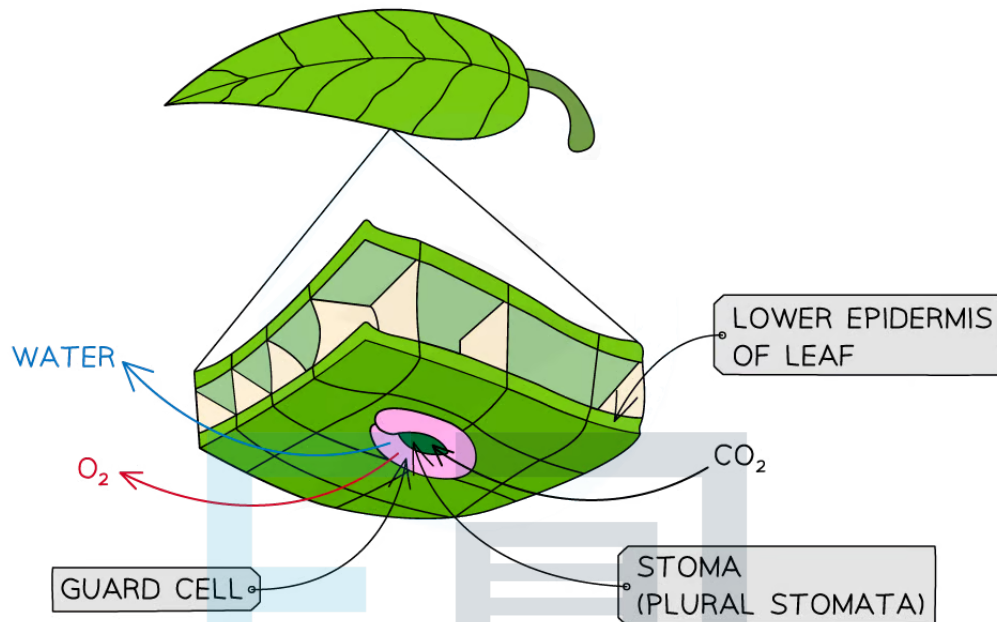

*The loss of water vapour from leaves by evaporation through the stomata is unavoidable as gas exchange for photosynthesis can only occur when the stomata are open*

### Factors affecting the rate of transpiration

- Air movement
  - **More air movement leads to increased rates of transpiration**
    - The air outside a leaf usually contains a **lower concentration of water vapour** than the air spaces inside a leaf, causing water vapour to **diffuse out of the leaf**
    - When the air is relatively still, **water molecules can accumulate** just outside the stomata, creating a **local area of high humidity**
    - **Less water vapour will diffuse out** into the air due to the **reduced concentration gradient**
    - Air currents, or wind, can **carry water molecules away from the leaf surface**, increasing the **concentration gradient** and causing more water vapour to diffuse out
- Temperature
  - **Higher temperatures lead to higher rates of transpiration**, up to a point at which **transpiration rates will slow**
    - An increase in temperature results in an **increase in the kinetic energy** of molecules
    - This increases the rate of transpiration as **water molecules evaporate out of the leaf at a faster rate**
    - If the temperature gets too high the **stomata close to prevent excess water loss**
    - This dramatically **reduces the rate of transpiration**



- Light intensity
  - **Higher light intensities will increase the rate of transpiration** up to a point at which **transpiration rates will level off**
    - **Stomata close in the dark** and their closure greatly reduces the rate of transpiration
    - **Stomata open when it is light** to enable gas exchange for photosynthesis; this increases the rate of transpiration
    - Once the stomata are all open any increase in light intensity has no effect on the rate of transpiration
- Humidity
  - **Higher humidity levels reduce the rate of transpiration**
    - If the humidity is high that means the **air surrounding the leaf surface is saturated with water vapour**
    - This causes the rate of transpiration to decrease as there is **no concentration gradient** between the inside of the leaf and the outside
      - At a certain level of humidity, an **equilibrium** is reached; water vapour levels inside and outside the leaf are the same, so there is no net loss of water vapour from the leaves

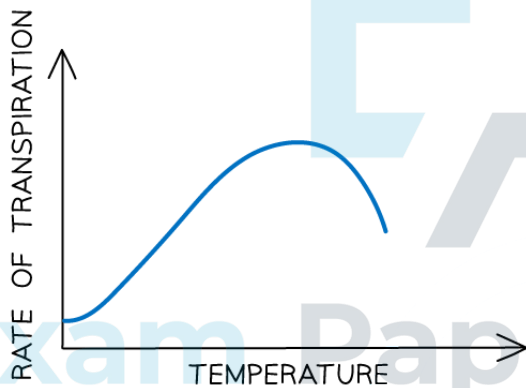

Copyright

© 2024 Exam Papers Practice

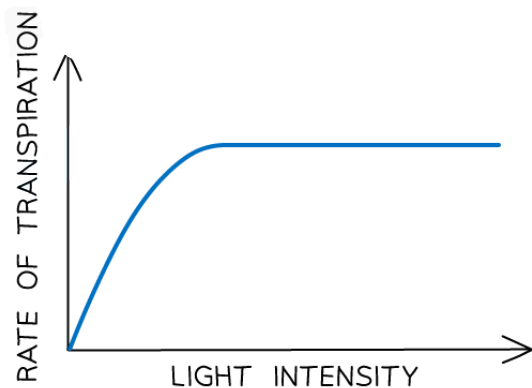
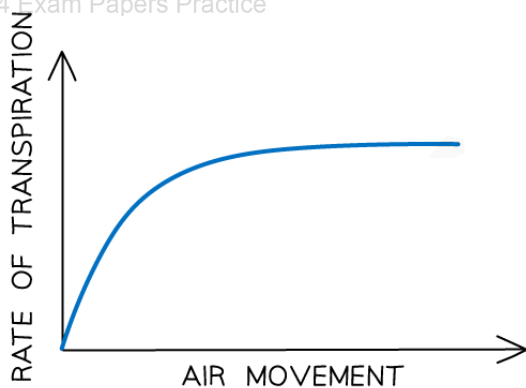

*Several environmental factors affect the rate of transpiration in plants*

### Exam Tip

Take note that the movement of water molecules during transpiration is **not** by osmosis. One of the requirements of osmosis is that water molecules move across a cell membrane, which does not happen during transpiration. We therefore say that water vapour **diffuses** out of the leaf through stomata during transpiration

## Measuring the rate of transpiration

- The **effect of environmental factors on the rate of transpiration** in plants can be measured using a piece of equipment called a **potometer**
  - Note that while potometers are used to measure transpiration rates, they **technically measure the rate of water uptake** rather than the rate of transpiration, as a small amount of the water taken up by a plant **will be used in photosynthesis**
    - Because the amount of water used in photosynthesis is so small in relation to the total amount of water that passes through a plant, the **rate of water uptake can reasonably be used to represent the rate of transpiration**
  - Different types of potometer exist
    - **Bubble potometers** measure the **movement of an air bubble along a water-filled tube** connected to a plant shoot as water is drawn up by the shoot
      - The position of the air bubble is **recorded at the start of an experiment**, and then a researcher can either measure **how far the bubble moves in a set amount of time**, or **time how long it takes for the bubble to move a certain distance**
    - **Mass potometers** measure the **change in mass of a water-filled test tube** connected to a plant shoot as it loses water over a set amount of time
- The effect of **various environmental factors** on transpiration can be measured by placing the potometer in different conditions e.g.
  - Wind speed
  - Humidity
  - Light intensity
  - Temperature

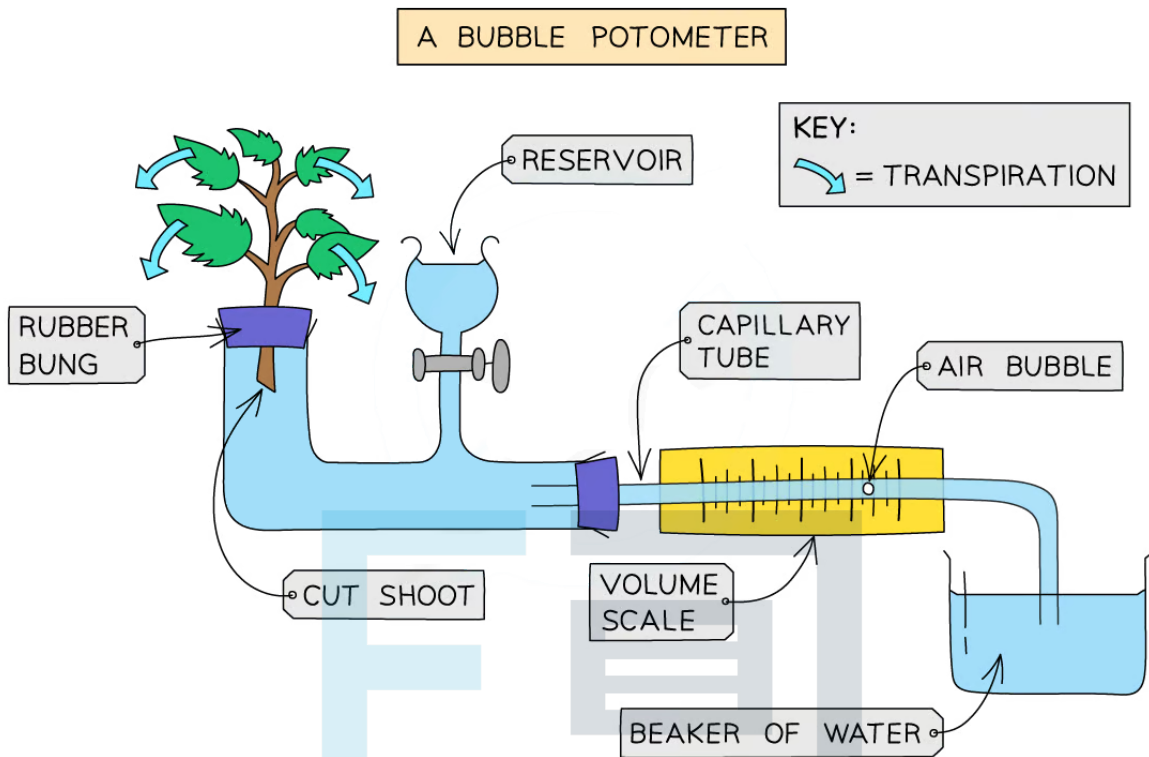

*A bubble potometer uses the movement of an air bubble to measure the rate at which water is drawn up by a plant shoot. In this image the air bubble will move to the left along the tube as the plant transpires*

- Environmental factors can be investigated in the following ways
  - Air movement
    - A **fan on different settings** could be used to vary the flow of air around a plant shoot
  - Humidity
    - Enclosing the plant shoot in a **plastic bag** can increase the humidity
    - A **humidifier or dehumidifier** could be used to give a measurable variation in humidity
  - Light intensity
    - A **lamp at different distances** or with **different types of light bulb** can be used to vary light intensity
  - Temperature
    - A **thermometer or temperature probe** can be used to find surroundings with different air temperatures
    - A **heater or air conditioner** can be used to give a measurable variation in temperature
- A researcher would need to be aware of the importance of **controlling any variables other than the variable being investigated** to ensure that any results are valid e.g. placing a plant shoot in different rooms could be a way of varying temperature, but might bring the risk of also varying light levels and humidity; these variables would need to be controlled

## Drawing Leaf Structure: Skills

### Drawing Leaf Structure

- You will be expected to identify the following **structures in the leaf of a dicotyledonous plant**:
  - Chloroplasts
  - Cuticle
  - Guard cells
  - Stomata
  - Upper and lower epidermis
  - Palisade mesophyll
  - Spongy mesophyll
  - Air spaces
  - Vascular bundles (xylem and phloem)

Structure of Leaf Diagram

# Exam Papers Practice

Copyright

© 2024 Exam Papers Practice



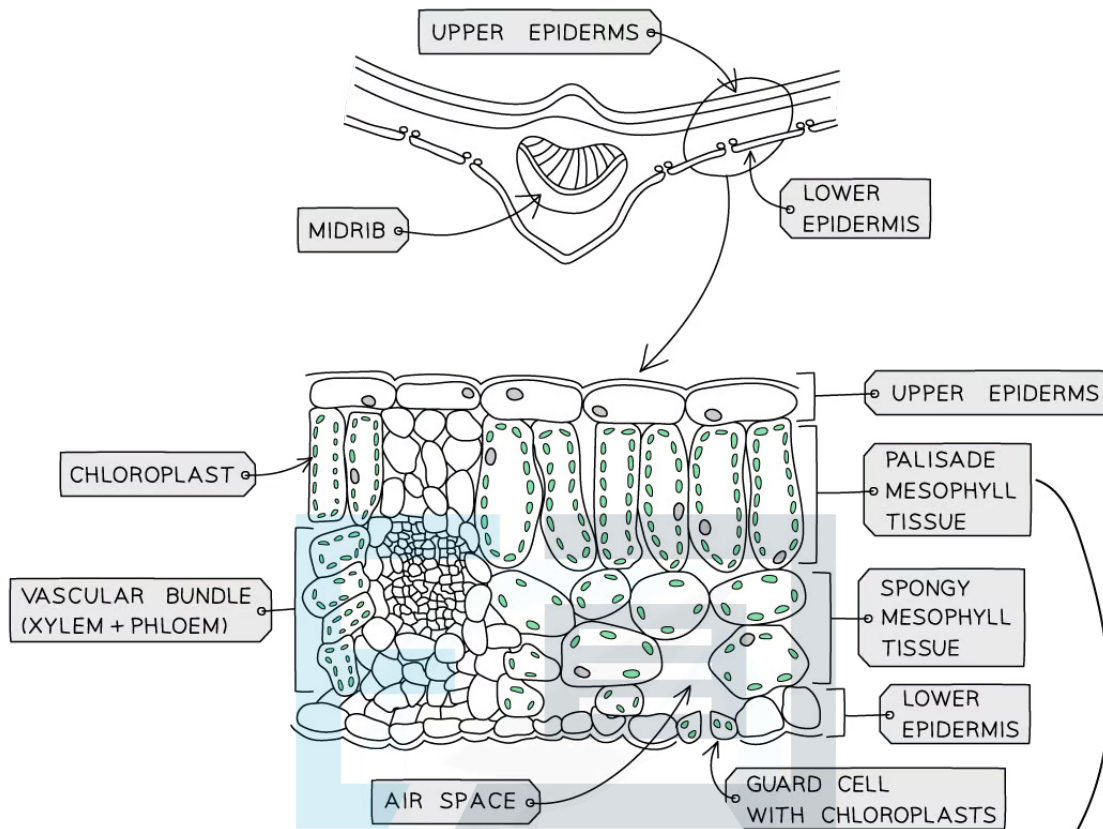

Exam Papers Practice

Copyright © 2024 Exam Papers Practice

THIS IS WHAT WE TYPICALLY THINK OF WHEN WE THINK OF A PLANT CELL, BUT IT'S JUST ONE OF THE TYPES OF CELL FOUND IN A LEAF

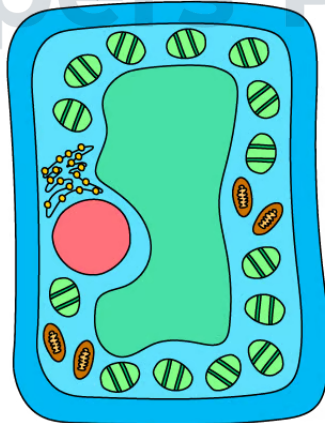

MADE FROM PALISADE MESOPHYLL CELLS

Diagram showing the transverse section of a leaf

## Drawing a plan diagram

- Plan diagrams are drawings made from micrographs or from viewing specimens under a **low magnification**
- Keep the following in mind when drawing a plan diagram:
  - **No individual cells** are drawn, only tissue layers enclosed by lines should be present
  - Pay attention to the **distribution of tissue** throughout the plant organ
  - Use a **sharp pencil** and draw **clear, continuous** lines
  - **Do not shade** any part of your drawing
  - Make sure your **proportions and observations** are accurate
    - Draw what you actually see, not what you would expect to see from a textbook
  - Draw your drawing **big enough** to fill up at least half the available space
- When labelling your plan diagram remember to:
  - **Use a ruler** to draw label lines, not freehand
  - **Avoid** using arrowheads and make sure the label lines **stop at the structure**
  - Make sure label lines **do not cross** each other
  - Write all labels **horizontally**, not at different angles

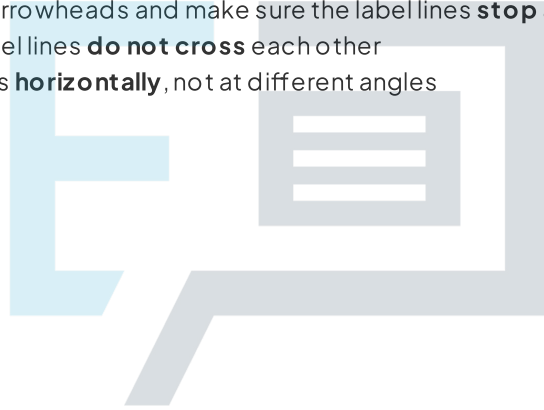

# Exam Papers Practice

Copyright

© 2024 Exam Papers Practice



**Worked example**

The following micrograph shows a transverse section of a dicotyledonous leaf.

Draw a labelled plan diagram of this micrograph.

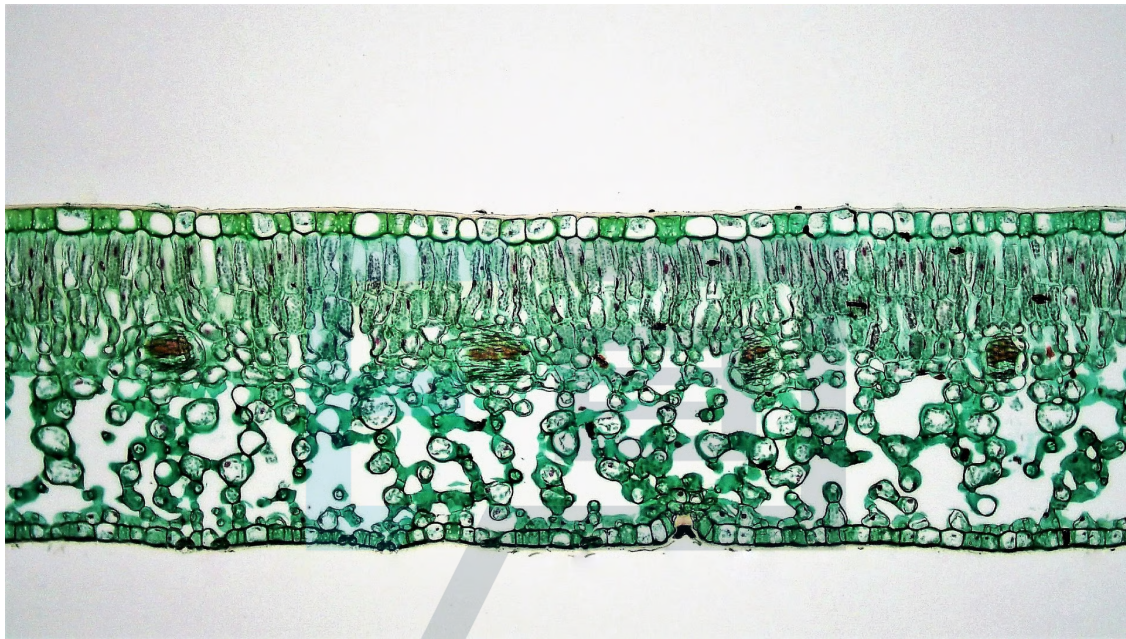

By Berkshire Community College Bioscience Image Library, Public domain, [Wikimedia](#)

Answer:

Exam Papers Practice

Copyright

© 2024 Exam Papers Practice

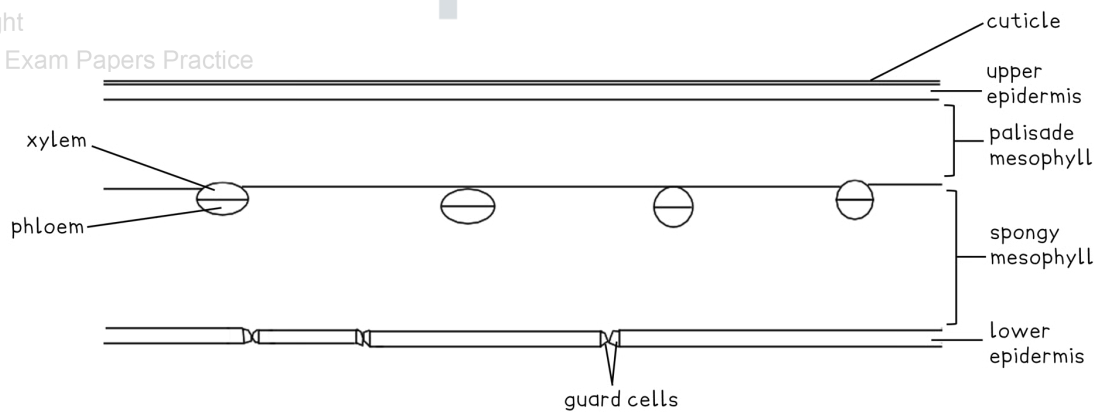

## Determining Stomatal Density: Skills

### Determining Stomatal Density

- The **density of stomata** (the number of stomata per unit of area) can be a useful measurement to biologists
  - To assess the plant's **likely response** to a dry spell of weather
  - To **predict its behaviour** in windy or wet climates if the plant was being moved for agricultural / horticultural reasons
- This technique can be used to assess how **stomatal density varies** from species to species

### Apparatus

- A plant to sample a leaf from
- Clear nail varnish (ideally solvent based)
- Sellotape
- Microscope
- Microscope slides
- Stage micrometer
- Counting device (clicker/ phone app etc.)
- Calculator

### Method

- Select a leaf from a **live plant** and cut it off the plant
  - **Geraniums** and **spider plants** make good subjects for this experiment
- Place the leaf upside down on a flat surface such as a tile or worktop
- Paint **clear nail varnish** onto the underside of the leaf
- Wait for the nail varnish to **dry** (approx. 5 minutes)
- **Peel off** the layer of varnish using sellotape
  - Discard the leaf
  - The layer of varnish now forms a **leaf cast**
- Place the dried varnish impression on a **microscope slide**
  - A **coverslip is not required** as this isn't a biological sample, just an impression of one
  - A **drop of water** is not required either, so long as the sample is laid flat on the slide
- Use the usual steps to **focus** on the sample (you can read about this in our revision note on [microscope skills](#))
- **Adjust the zoom** such that a **countable number** of stomata are visible in the field of view
  - Between **15 and 100** is ideal
  - Even if a stoma is partially visible at the edge, still count it as 1
- **Count the stomata** in that field of view
  - You may wish to use a **clicker** or **phone app** so you don't lose count!



- **Move the field of view** to another area of the nail varnish layer and repeat
- Count at least 3 separate fields of view and take a mean value
  - Repeat readings allow you to **eliminate anomalous results** and calculate a **reliable mean**

### Measurements to take

- Use a **stage micrometer** to measure the **diameter** of the field of view
  - This has to be **at the same magnification** power that you used when counting the stomata
- The stage micrometer will be calibrated in micrometers
  - A typical microscope allows the scientist to look at a field of view of about 0.5 mm diameter when on full power ( $\times 400$ )
- You will have calculated a mean number of stomata per field of view from the previous stage
- You can read about using a stage micrometer in our revision notes on [microscope skills](#)

### Worked example

A study reveals a mean count of **16 stomata** per field of view at a magnification of  $\times 400$ . The stage micrometer calculates the **diameter** of the field of view at a magnification of  $\times 400$  to be **0.46mm**

Calculate the stomatal density based on these data. Give units in stomata per  $\text{mm}^2$

Use a value of  $\pi = 3.14$  and give your answer to the nearest whole number of stomata.

Exam Papers Practice

Copyright

© 2024 Exam Papers Practice

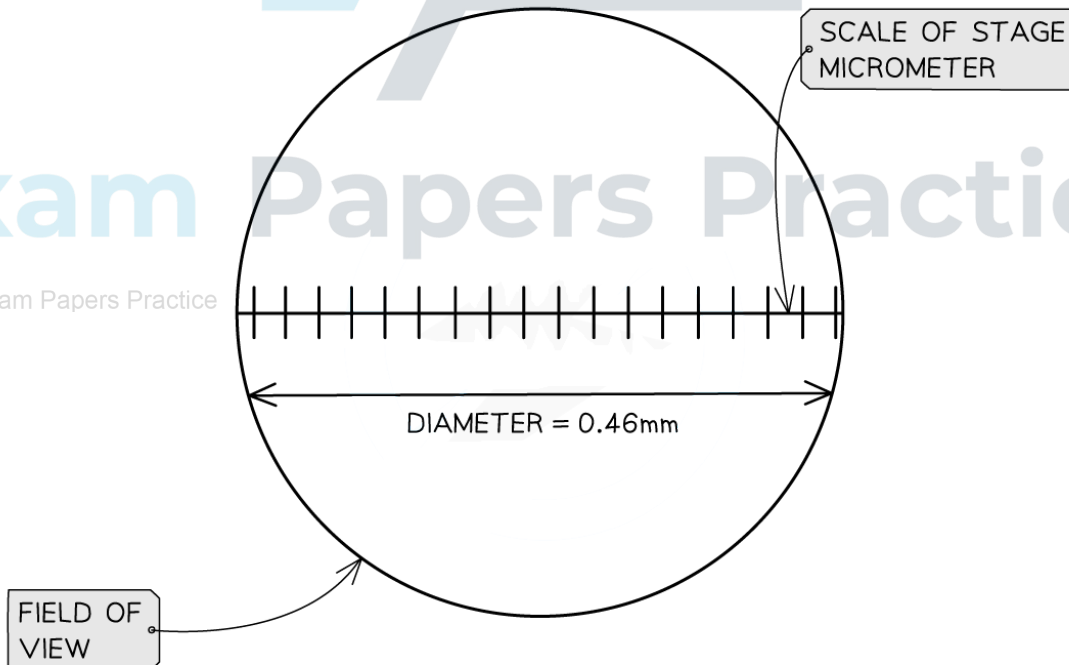



COUNT = 16 STOMATA IN THIS FIELD OF VIEW

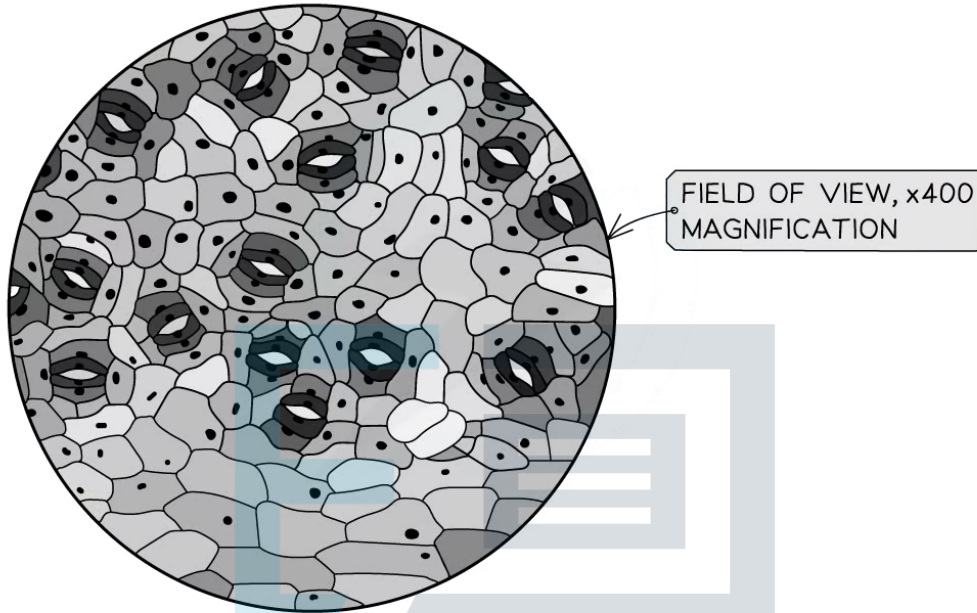

Answer:

Step 1: Calculate the radius of the field of view

$$\text{Radius} = \text{Diameter} \div 2$$

$$\text{Radius} = 0.46 \text{ mm} \div 2 = 0.23 \text{ mm}$$

Copyright

© 2024 Exam Papers Practice

Step 2: Calculate the area of the field of view

$$\text{Area} = \pi r^2 = \pi \times 0.23^2$$

$$\text{Area} = 0.1662 \text{ mm}^2$$

Step 3: Divide the mean number of stomata by the area of the field of view to calculate density

$$\text{Density} = 16 \div 0.1662 = 96.27 \text{ stomata per mm}^2$$

Step 4: Round to the required precision (nearest whole number)

$$\text{Density} = 96 \text{ stomata per mm}^2$$

## Limitations

- **Not all plant species** have easily accessible stomata that create a strong imprint
- Solvent-based nail varnish can **destroy** some of the cell structure it comes into contact with
- Does the plant grow **more stomata** (guard cells) according to the conditions in each individual habitat?
- Water-based nail varnish is safer to use but dries **more slowly**

## NOS: Reliability of quantitative data is increased by repeating measurements

- Reliability refers to the **level of trust** that we can place in numerical measurements
  - These types of measurements are known as **quantitative data**
- Repeating the stomatal count for the same species of leaf under the same conditions will **increase the reliability** of the results
  - It is very possible that the data gathered during a single count could contain errors that we may not be aware of
  - Taking repeated measurements will identify **anomalous measurements** and allow us to **calculate a mean**
    - Anomalous measurements are those that **deviate** from the expected measurements
    - Anomalies are **omitted** when calculating the mean for a data set
- If repeated stomatal counts deliver similar results, the data is said to be **reliable**
  - We can therefore place a higher level of trust in the data than what would have been possible if we got very different results with every count
- Repeating measurements is a crucial step in gathering data during a scientific investigation

### Exam Tip

Anomalous results are sometimes referred to as outliers.

Copyright

© 2024 Exam Papers Practice