

Cell structure 2

Level: CIE A Level 9700

Subject: Biology

Exam Board: Suitable for all boards

Topic: Cell structure 2

Type: Questionnaire

To be used by all students preparing for CIE Biology A Level 9700 foundation or higher tier but also suitable for students of other boards.



1

The diagram shows the structure of a plasma membrane.

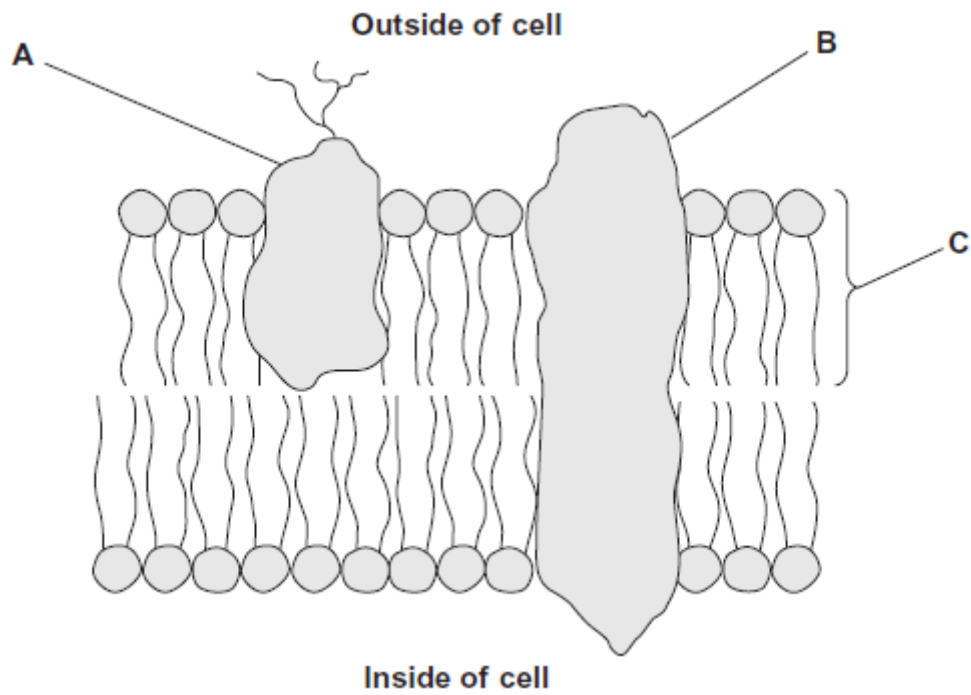

(a) Name

protein A _____

protein B _____

molecule C _____

(3)

(b) Name **two** structures found in a prokaryotic cell that are **not** found in a human cell.

1. _____

2. _____

(2)

(Total 5 marks)

2

The drawing shows part of a human cell.

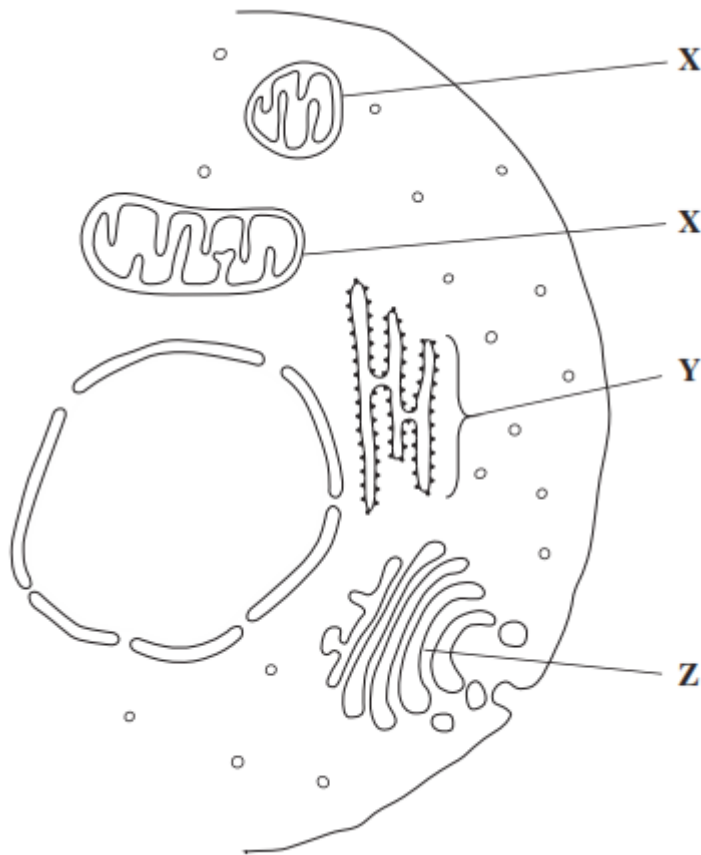

(a) Name organelles

X _____

Y _____

(2)

(b) (i) The organelles labelled X all have very similar shapes in this cell. Explain why they appear to have different shapes in this drawing.

(Extra space) _____

(1)



- (ii) Large numbers of organelles **X** and **Z** are found in mucus-secreting cells.
Explain why.

(Extra space) _____

(2)
(Total 5 marks)

3

The diagram shows a bacterium.

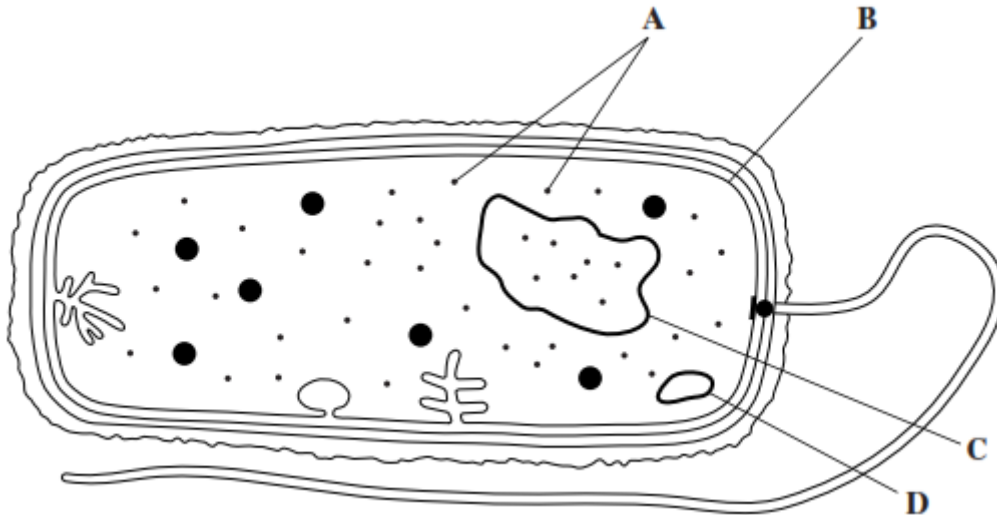

(a) Name

(i) organelle **A** _____

(1)

(ii) structure **B** _____

(1)

(b) Give **two** ways in which the structure of this bacterium is different from the structure of cells lining the alveoli of a human lung.

1. _____

2. _____

(2)



- (c) Structures **C** and **D** are made of the same type of biological molecule. They have a similar function.

What is the function of **C** and **D**?

(1)
(Total 5 marks)



4

The diagram shows the outer layers of three different cells, **A**, **B** and **C**.

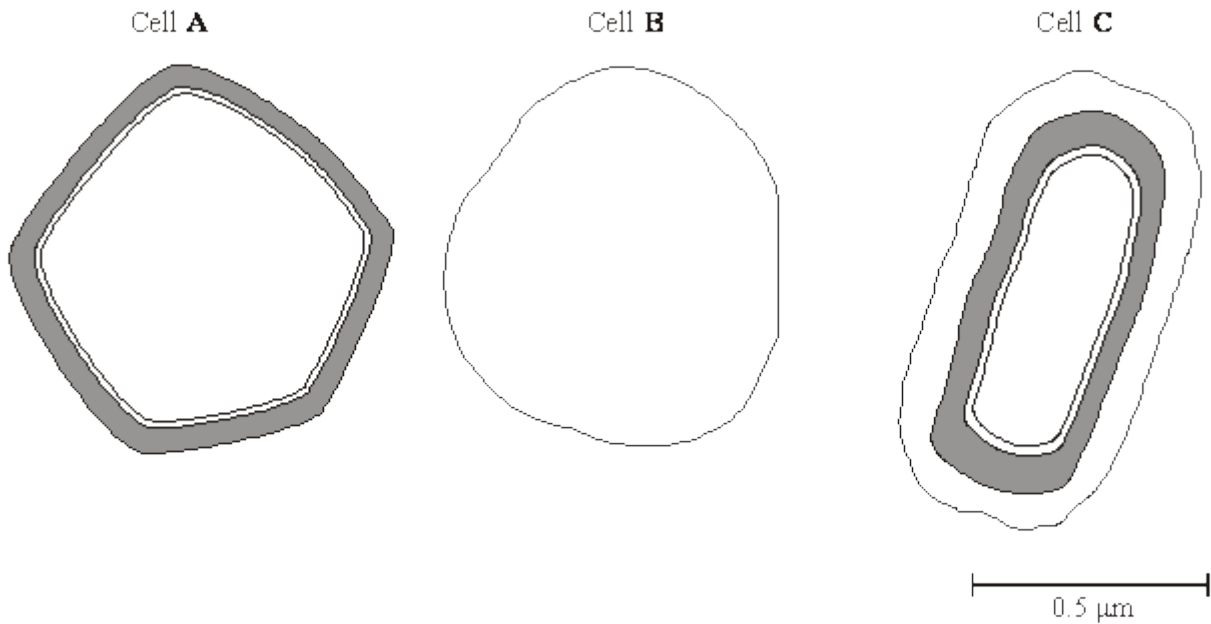

(a) What is the evidence from the diagram that

(i) cell **B** is an animal cell,

(1)

(ii) cell **C** is a prokaryotic cell?

(1)

(b) Explain how you would calculate the magnification of cell **C**.

(1)

(c) Cell **A** is a plant cell. Name a polysaccharide which may be found in cell **A** but would not be found in the animal cell.

(1)



(d) Penicillin is an antibiotic. It prevents the formation of bacterial cell walls. As a result, bacterial cells that have been treated with penicillin swell and burst as water enters.

(i) Explain how water enters a bacterial cell.

(2)

(ii) Suggest why penicillin has no effect on plant cells.

(1)

(Total 7 marks)

5

The diagram shows how some organelles may be distinguished from each other.

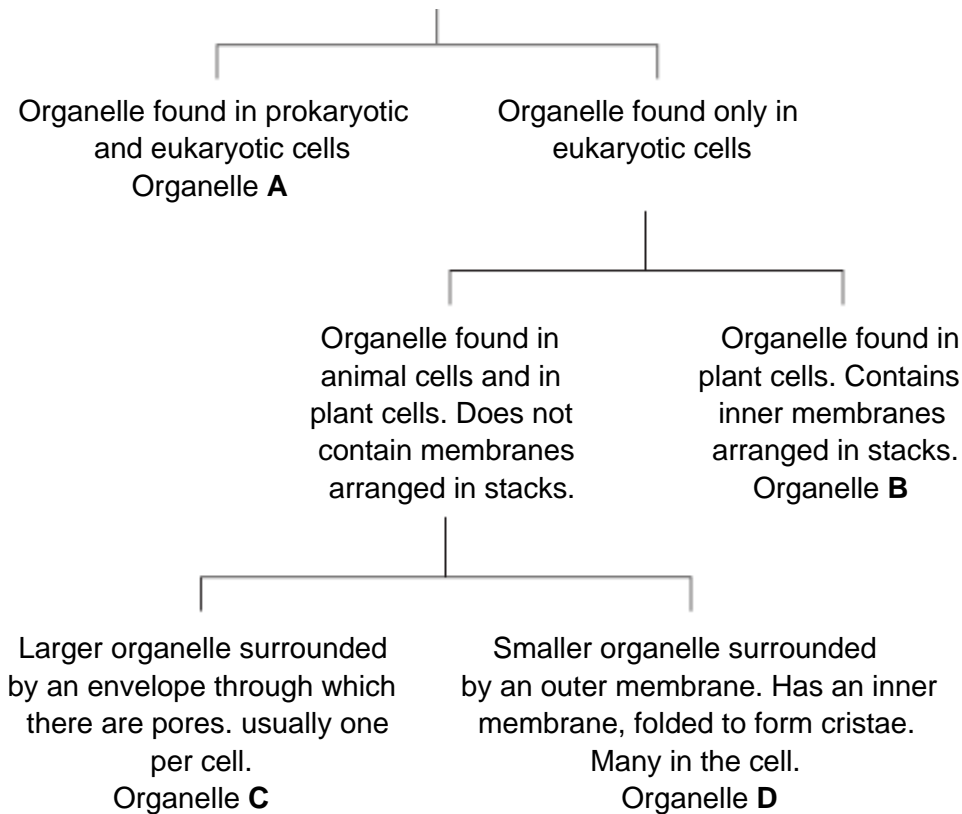

(a) (i) Name organelle **B**.

(1)



(ii) Describe the function of organelle **B**.

(2)

(b) Which of organelles **A**, **B**, **C** or **D**

(i) is a ribosome;

(1)

(ii) contains most of the DNA found in a plant cell?

(1)

(c) Some liver tissue was ground, filtered and centrifuged to make a suspension of organelle **D**.

(i) Explain why the solution in which the liver tissue was ground should be ice-cold.

(1)

(ii) The ground liver was centrifuged at low speed. The pellet that formed at the bottom of the centrifuge tube was thrown away and the supernatant centrifuged again at higher speed. Explain why it was necessary to first centrifuge the ground liver at low speed in order to obtain a suspension of organelle **D**.

(2)

(Total 8 marks)



6 Moulds belong to a group of organisms called fungi. When mould is examined with a microscope it is seen to consist of long, colourless threads called hyphae.

A student investigated the growth of fungal hyphae. The diagram shows part of a hypha seen under a microscope at the beginning of a lesson and again at the end of the lesson.

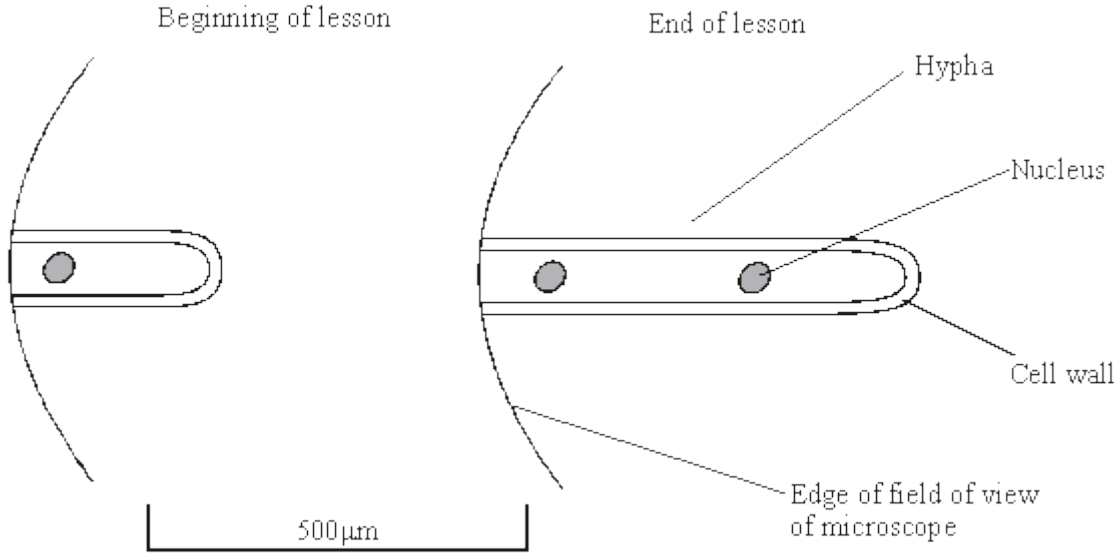

(a) Give **one** piece of evidence from the diagram that fungi are eukaryotic.

(1)

(b) (i) By how much had the hypha grown during the lesson? Show your working.

Answer: _____ μm

(2)

(ii) Explain how you could use your answer to calculate the rate of growth of this hypha.

(1)



- (c) Under the microscope, small granules were seen in the hypha. Describe how you could show that these granules consisted of starch.

(2)

(Total 6 marks)

7

- (a) A plant cell was observed with an optical microscope. Describe how the length of the cell could be estimated.

(2)

- (b) The water potential of a plant cell is -400 kPa. The cell is put in a solution with a water potential of -650 kPa. Describe and explain what will happen to the cell.

(3)



(c) A group of students investigated the effect of sucrose concentration on the change in length of cylinders of tissue cut from a young carrot. They measured the initial lengths of the carrot cylinders, then placed one in each of a number of sucrose solutions. After 18 hours, they removed the carrot cylinders and measured their final lengths. Some of the results are shown in the table.

Concentration of sucrose / mol dm^{-3}	Percentage decrease in length of carrot cylinder
0.4	4.2
0.5	8.7
0.6	13.0
0.7	16.8
0.8	18.1
0.9	18.1
1.0	18.1

(i) The carrot cylinders were left for 18 hours in the sucrose solutions. Explain why they were left for a long time.

(1)

(ii) Explain how you would use a graph to predict the concentration of sucrose that would result in no change in length of the carrot cylinders.

(2)



- (iii) Young carrots store sugars in their tissues but, in older carrots, some of this is converted to starch. How would using cylinders of tissue from older carrots affect the results obtained for a sucrose solution of 0.6 mol dm^{-3} ? Give a reason for your answer.

(2)

(Total 10 marks)

8

The diagram shows a cell from a potato.

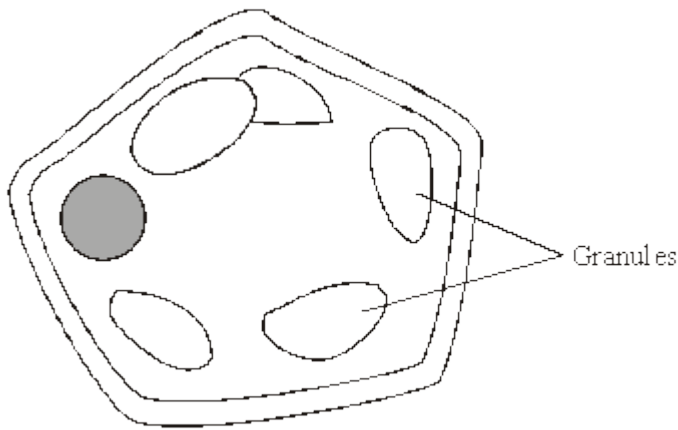

- (a) Give **two** features which may be found in a prokaryotic cell which would not be found in this cell.

1. _____

2. _____

(2)

- (b) (i) Describe how you could confirm that the granules contained starch.

(1)

- (ii) Name **one** polysaccharide other than starch that would be found in this cell.

(1)



(c) Explain **one** advantage of storing starch rather than glucose in potato cells.

(2)

(Total 6 marks)

9 Liver was ground to produce a homogenate. The diagram shows how fractions containing different cell organelles were produced from the filtered homogenate.

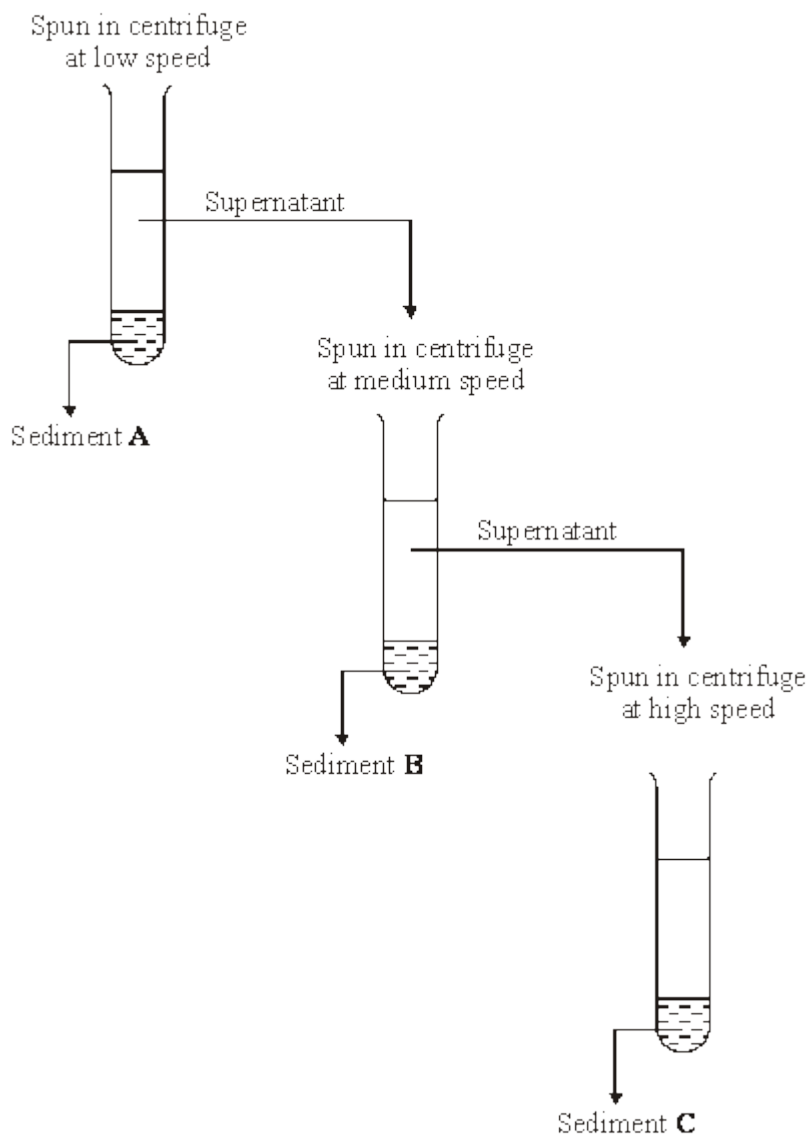



(a) Explain why the homogenate was filtered before spinning at low speed in the centrifuge.

(2)

(b) The main organelles present in sediment **B** were mitochondria. Suggest the main organelles present in

(i) sediment **A**;

(1)

(ii) sediment **C**.

(1)

(c) What property of cell organelles allows them to be separated in this way?

(1)

(d) Explain why the organelles in sediment **C** could be seen with a transmission electron microscope but not with an optical microscope.

(2)

(Total 7 marks)



10

Read the following passage.

In a human, there are over 200 different types of cell clearly distinguishable from each other. What is more, many of these types include a number of different varieties. White blood cells, Wfor example, include lymphocytes and granulocytes.

5 Although different animal cells have many features in common, each type has adaptations associated with its function in the organism. As an example, most cells contain the same organelles, but the number may differ from one type of cell to another. Muscle cells contain many mitochondria, while enzyme-secreting cells from salivary glands have particularly large amounts of rough endoplasmic reticulum.

10 The number of a particular kind of organelle may change during the life of the cell. An example of this change is provided by cells in the tail of a tadpole. As a tadpole matures into a frog, its tail is gradually absorbed until it disappears completely. Absorption is associated with an increase in the number of lysosomes in the cells of the tail.

Use information from the passage and your own knowledge to answer the following questions.

(a) Explain the link between.

(i) mitochondria and muscle cells (lines 6 - 7);

(3)

(ii) rough endoplasmic reticulum and enzyme-secreting cells from salivary glands (lines 7 - 8).

(2)



- (b) Use information in the passage to explain how a tadpole's tail is absorbed as a tadpole changes into a frog.

(2)

- (c) Starting with some lettuce leaves, describe how you would obtain a sample of undamaged chloroplasts. Use your knowledge of cell fractionation and ultracentrifugation to answer this question.

(6)

(Total 13 marks)



11 The thyroid gland is an organ in the neck. The diagram shows the process in which epithelial cells from the thyroid gland make and secrete a protein called thyroglobulin.

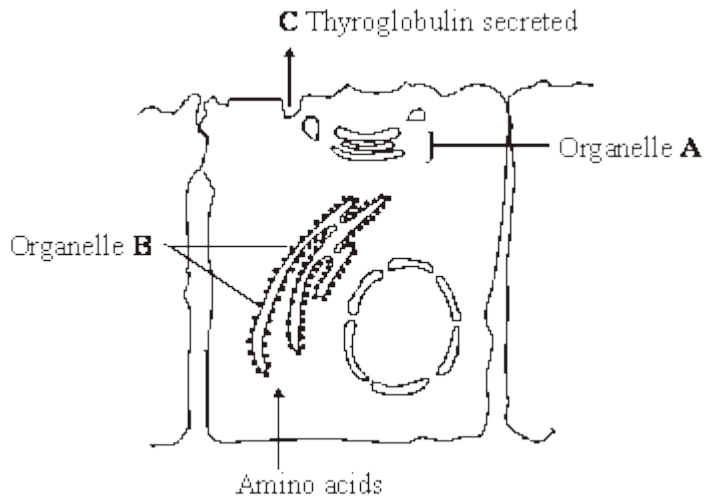

(a) Name

(i) organelle **A**;

(1)

(ii) the process by which thyroglobulin is secreted from the cell at **C**.

(1)

(b) (i) Describe the part played by the organelles labelled **B**.

(1)

(ii) Organelle **B** is very small. It cannot be seen when thyroid cells are examined with an optical microscope but it can be seen with an electron microscope. Explain why this organelle can be seen with an electron microscope.

(2)

(Total 5 marks)



12

The drawing shows an electron micrograph of a section through part of an alveolus from a lung.

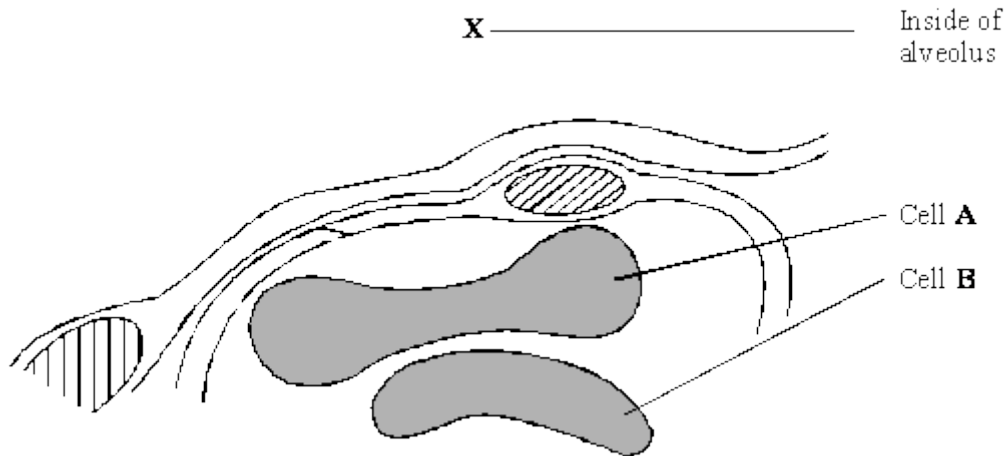

- (a) Describe the path of a molecule of oxygen from the air in the alveolus at **X** to the plasma membrane of cell **A**.

(1)

- (b) Cell **A** is a eukaryotic cell. Give **two** features that may be found in a prokaryotic cell which are not found in cell **A**.

1. _____

2. _____

(2)

- (c) Cells **A** and **B** are biconcave discs. Explain **one** advantage of a biconcave disc over a spherical cell of the same volume in transporting oxygen.

(2)

- (d) The diameter of a human red blood cell is $7\ \mu\text{m}$.
- (i) Calculate the magnification of the drawing. Show your working.

Magnification = _____

(2)

- (ii) In calculating the magnification, what assumption did you have to make about how the section was cut?

(1)

(Total 8 marks)

13

Read the following passage.

Human milk contains all the nutrients a young baby needs in exactly the right proportions. It is formed in the mammary glands by small groups of milk-producing cells. These cells absorb substances from the blood and use them to synthesise the lipids, carbohydrates and proteins found in milk. Milk-producing cells are roughly cube-shaped and have a height to breadth ratio of approximately 1.2 : 1.

The main carbohydrate in milk is lactose. Lactose is a disaccharide formed by the condensation of two monosaccharides, glucose and galactose. (A molecule of galactose has the same formula as a molecule of glucose – the atoms are just arranged in a different way.)

10 Lactose is synthesised in the Golgi apparatus and transported in vesicles through the cytoplasm. Because lactose is unable to escape from these vesicles, they increase in diameter as they move towards the plasma membrane. The vesicle membranes fuse with the plasma membrane and the vesicles empty their contents out of the cell.

Use the information from the passage and your own knowledge to answer the following questions.

- (a) (i) The breadth of a milk-producing cell is $26\ \mu\text{m}$. Calculate the height of this cell.

Height = _____ μm

(1)



- (ii) Describe and explain how you would expect the height to breadth ratio of an epithelial cell from a lung alveolus to differ from the height to breadth ratio of a milk-producing cell.

(2)

- (b) How many oxygen atoms are there in a molecule of

- (i) galactose;

(1)

- (ii) lactose?

(1)

- (c) The lactose-containing vesicles increase in diameter as they move towards the plasma membrane of the milk-producing cell (lines 11-12). Use your knowledge of water potential to explain why.

(2)

- (d) Suggest **one** advantage of milk-producing cells containing large numbers of mitochondria.

(2)



- (e) Some substances pass through the plasma membrane of a milk-producing cell by diffusion. Describe the structure of a plasma membrane and explain how different substances are able to pass through the membrane by diffusion.

(6)

(Total 15 marks)

14

The diagram shows the structure of a chloroplast.

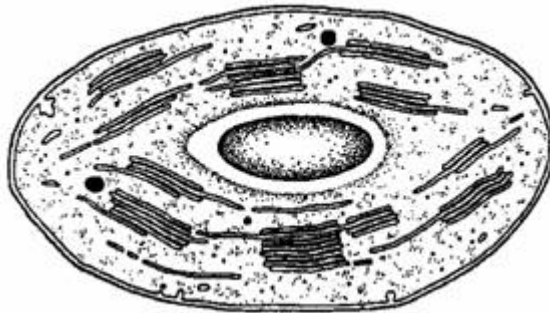

- (a) Label the diagram with an **X** to show where the light-dependent reactions take place and with a **Y** to show where the light-independent reactions take place.

(1)



- (b) The photolysis of water is an important part of the process of photosynthesis. Describe what happens in the photolysis of water.

(2)

- (c) ATP and reduced NADP are two products of the light-dependent reactions. Describe **one** function of **each** of these substances in the light-independent reactions.

ATP _____

Reduced NADP _____

(2)

(Total 5 marks)

15

- (a) The diagram shows two organelles found in a eukaryotic cell.



A



B

- (i) Name the organelles.

A _____

B _____

(1)

- (ii) Explain how the inner membrane is adapted to its function in organelle A.

(2)



(b) Give **one** feature of a prokaryotic cell that is not found in a eukaryotic cell.

(1)

(c) Describe how a sample consisting only of chloroplasts could be obtained from homogenised plant tissue.

(3)

(Total 7 marks)



16

The figure shows a section through a palisade cell in a leaf as seen with a light microscope. The palisade has been magnified $\times 2000$.

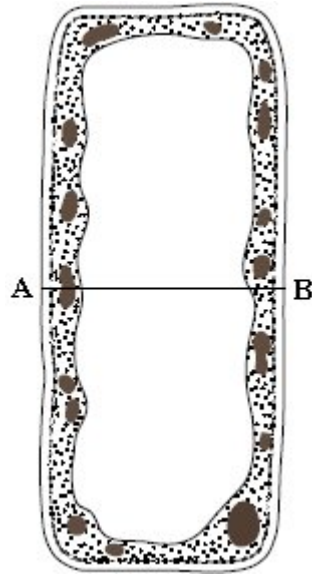

$\times 2000$

- (a) Calculate the actual width of the cell, measured from **A** to **B**, in μm . Show your working

Answer _____ μm

(2)

- (b) Palisade cells are the main site of photosynthesis. Explain **one** way in which a palisade cell is adapted for photosynthesis.

(2)

(Total 4 marks)



17

The diagram shows the structure of a mitochondrion.

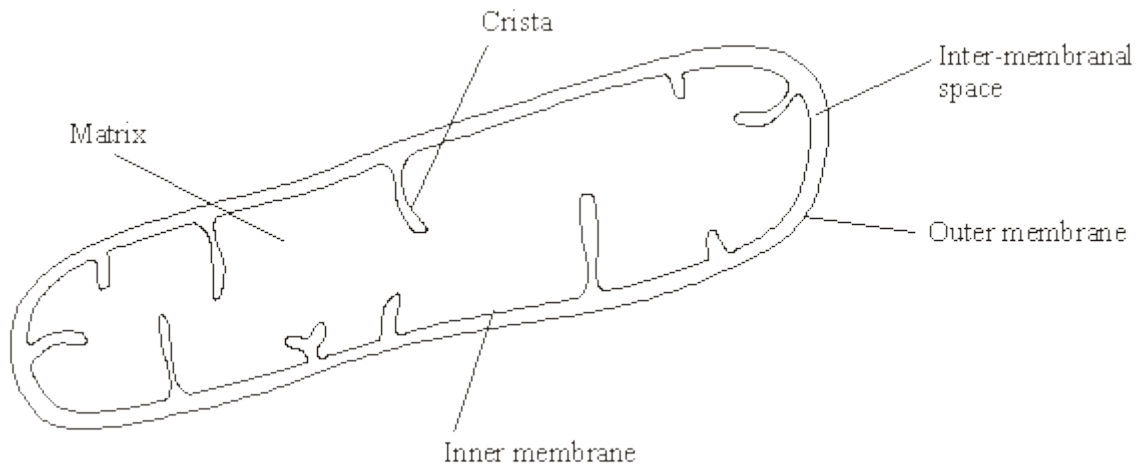

(a) In which part of the mitochondrion does the Krebs cycle take place?

(1)

(b) Name **two** substances for which there would be net movement into the mitochondrion.

1. _____

2. _____

(2)

(c) The mitochondria in muscles contain many cristae. Explain the advantage of this.

(2)

(Total 5 marks)

18

(a) The diagram shows a bacterial cell.

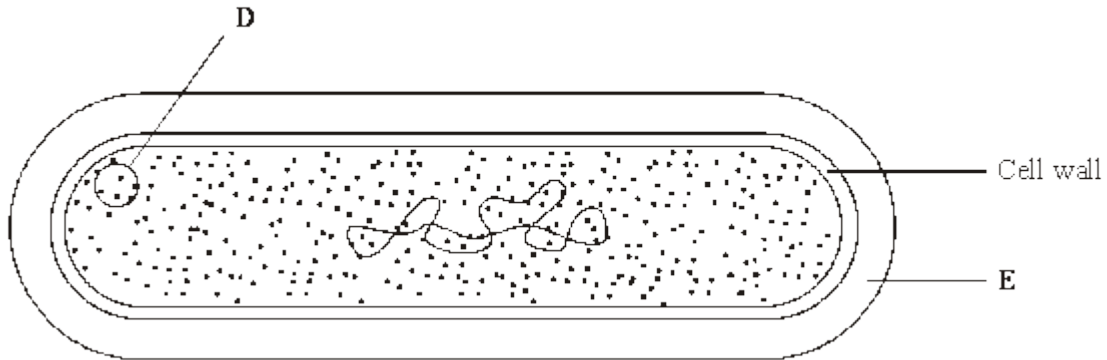

(i) Name the parts labelled **D** and **E**.

D _____

E _____

(2)

(ii) Give **one** function of the cell wall.

(1)

(b) Name **two** structures present in eukaryotic cells that are not present in the cells of prokaryotes.

1. _____

2. _____

(2)

(c) Several small pieces of a saprophytic fungus were placed on a starch agar plate. After 48 hours the iodine solution was poured over the starch agar. The result is shown in the diagram below.

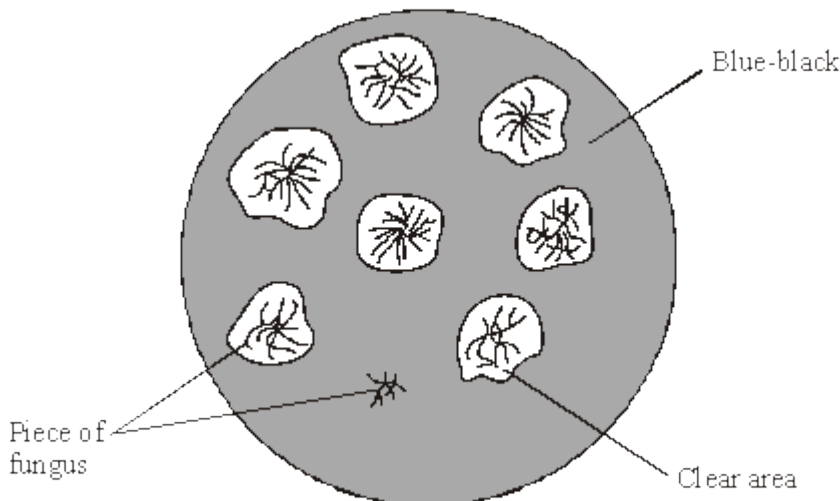



- (i) Explain why there is a clear area around most of the pieces of fungus.

(2)

- (ii) Suggest why one piece of fungus has no clear area round it.

(1)

(Total 8 marks)

- 19** (a) Small samples of plant tissue were placed in a cold, isotonic solution and then treated to break open the cells to release the organelles. The different organelles were then separated. Describe a technique that could be used to

- (i) break open the cells;

- (ii) separate the organelles.

(2)



(b) One group of organelles was placed in a hypotonic solution. The diagram shows one of these organelles seen under an electron microscope before and after it was placed in the hypotonic solution.

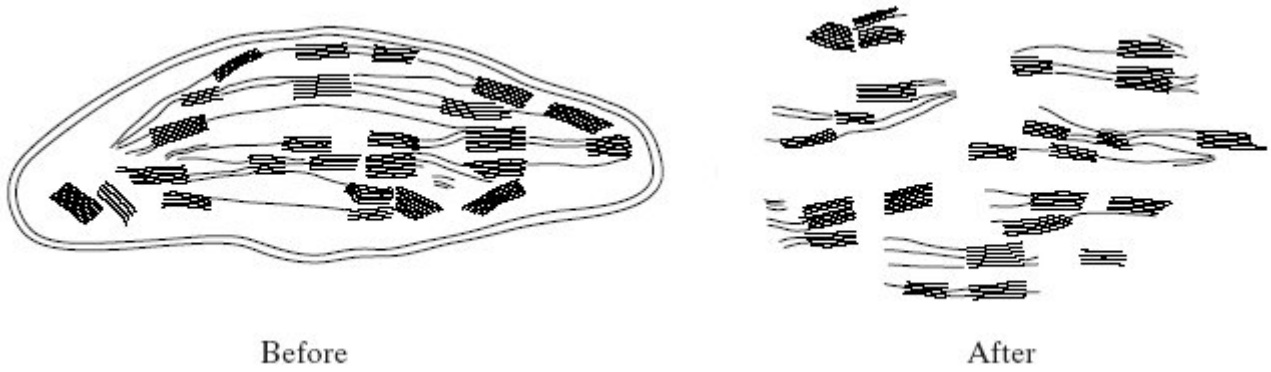

Name the organelle.

(1)
(Total 3 marks)

20

The diagram shows a bacterium.

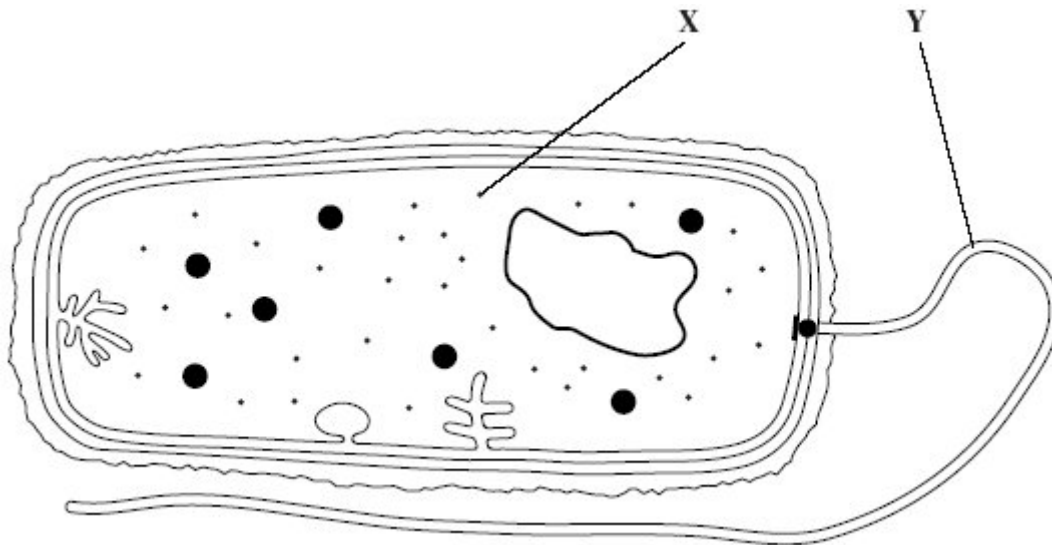

(a) Give the function of

(i) organelle X;

(ii) organelle Y.

(2)



S (b) (i) Give **two** ways in which the structure of this bacterium is similar to the structure of a cell lining the human small intestine.

1. _____

2. _____

(2)

(ii) Give **two** ways in which the structure of this bacterium differs from the structure of a cell lining the human small intestine.

1. _____

2. _____

(2)

(Total 6 marks)

21

S The diagram shows a single-celled organism called *Chlamydomonas*.

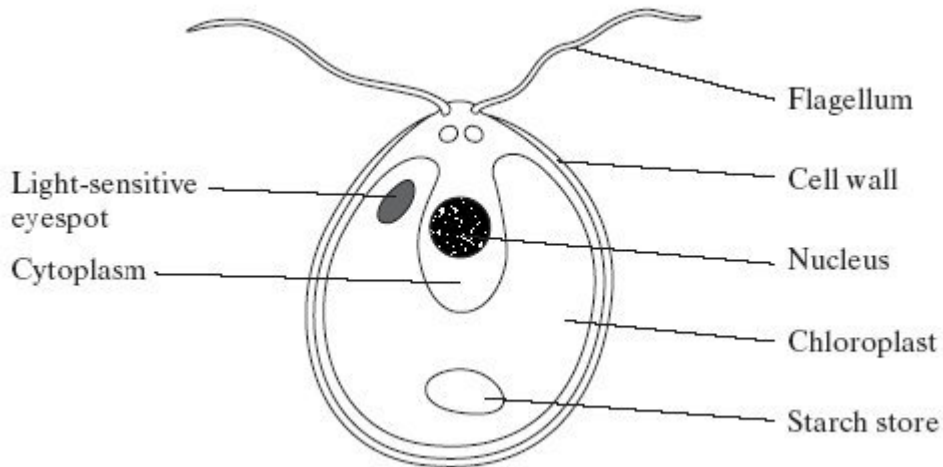

(a) *Chlamydomonas* lives in fresh-water ponds. It uses its flagella to swim towards light of moderate intensity but away from very bright light. Using information in the diagram, explain the advantage of this behaviour.

(2)



(b) A *Chlamydomonas* cell has two flagella. These flagella contain a single sort of protein. A flagellum consists of a bundle of 242 filaments. Each filament consists of 7500 protein molecules. Each protein molecule contains 900 amino acid units.

- (i) What would be the minimum number of nucleotides in the coding region of the mRNA used to synthesise this protein?

(1)

- (ii) In an investigation, a culture of *Chlamydomonas* was treated in a way that caused them to lose their flagella without any other damage to the cells. The flagella grew back to their original length in 60 minutes.

How many amino acid molecules would be incorporated into each growing flagellum per minute? Show your working.

Answer _____

(2)



- (c) The researchers investigated the rate at which the flagella grew in three different media.
1. A medium containing actinomycin D, which prevents transcription by binding to the guanine in DNA
 2. A medium containing puromycin, which prevents translation by attaching to ribosomes
 3. A control medium

The results are shown in the graph.

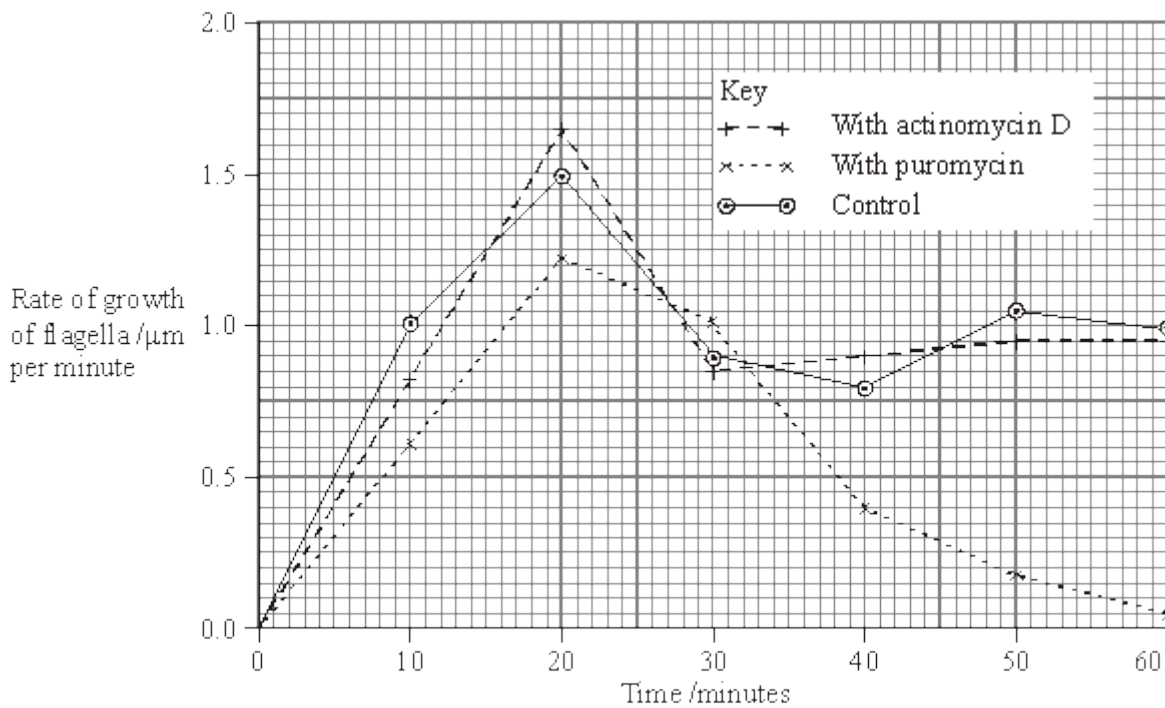

- (i) Describe how the rate of growth was affected by puromycin.

(2)



(ii) The researchers concluded

1. that the cells used mRNA that is already present in the cytoplasm for the regrowth of the flagella;
2. that some of the regrowth uses protein molecules already present in the cell.

Explain the evidence for each of these conclusions.

1. _____

2. _____

(4)

(Total 11 marks)

22

The diagram shows part of an animal cell as seen through an electron microscope.

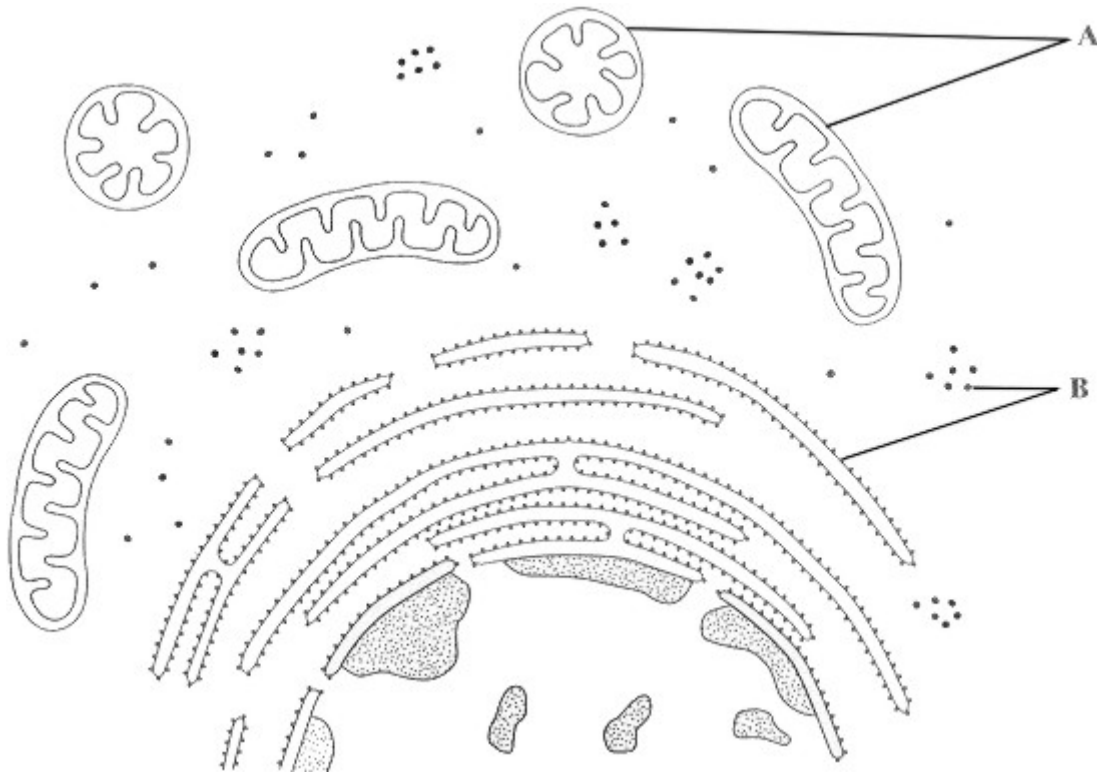

(a) Name the organelles labelled **A** and **B**.

A _____

B _____

(2)

(b) Explain why the shapes of the two organelles labelled **A** appear different.

(2)

(c) Give the function of organelle **B**.

(1)



- (d) The epithelial cells of the small intestine have large numbers of organelle **A**. Explain how this is an adaptation for the function of these cells.

(3)
(Total 8 marks)

23

The electron micrograph shows part of a chloroplast.

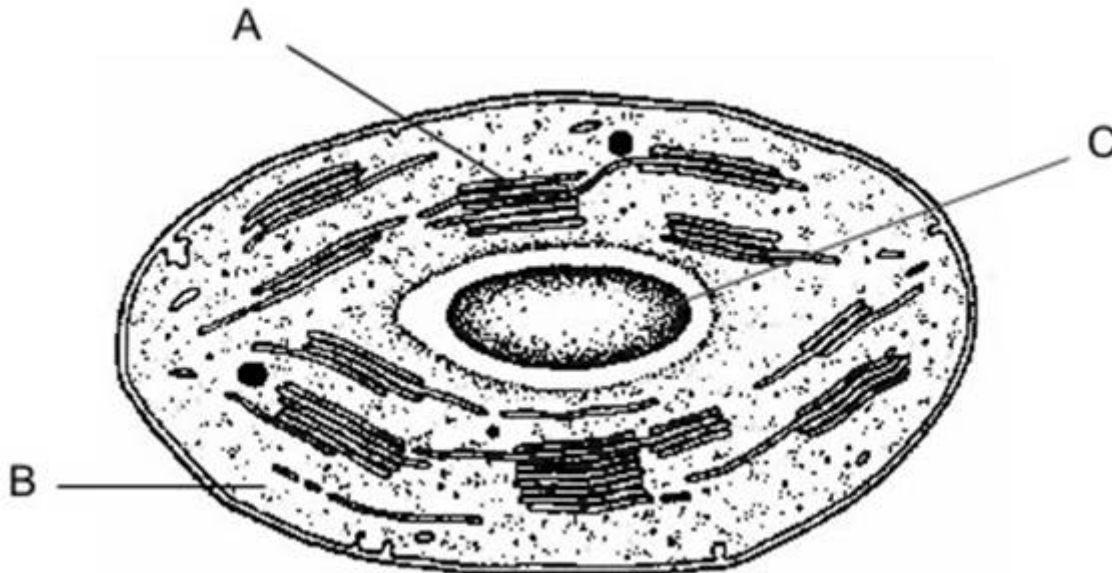

- (a) Name the parts labelled **A** and **B** and, for each, describe **one** role in the process of photosynthesis.

A Name _____

Role _____

(2)

B Name _____

Role _____

(2)

- (b) (i) Name the main substance present in the part labelled **C**.

(1)



(ii) How is this substance formed?

(1)
(Total 6 marks)

24

The drawing shows part of a plant cell as seen with an electron microscope.

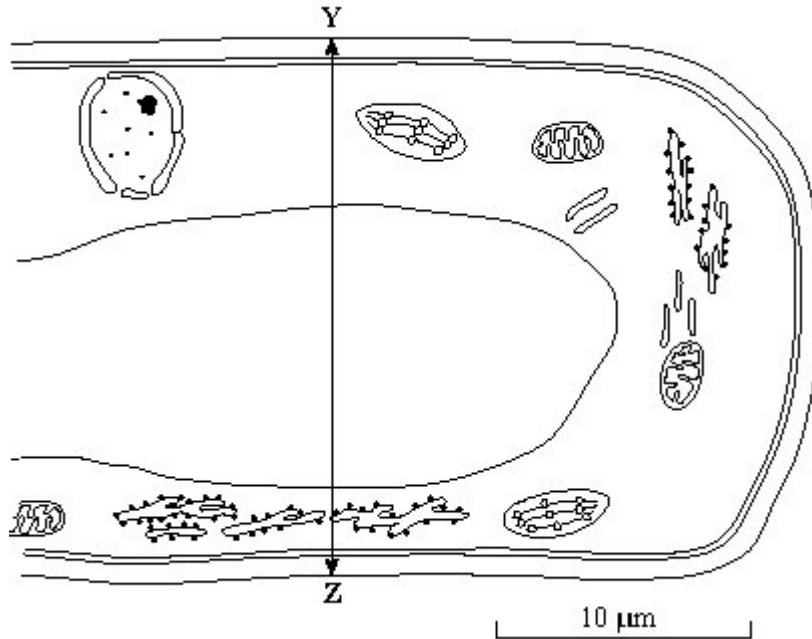

(i) Give **two** features shown in the drawing which are evidence that this cell is eukaryotic.

1. _____

2. _____

(2)

(ii) Calculate the actual width of the cell from **Y** to **Z**. Give your answer in micrometres (μm) and show your working.

Answer _____ μm

(2)



(iii) Give **one** way in which a typical animal cell differs from the cell shown in the drawing.

(1)

(Total 5 marks)

25 (a) Changes to the protein coat of the influenza virus cause antigenic variability. Explain how antigenic variability has caused some people to become infected more than once with influenza viruses.

(2)

(b) The drawings show the changes in a B lymphocyte after stimulation by specific antigens.

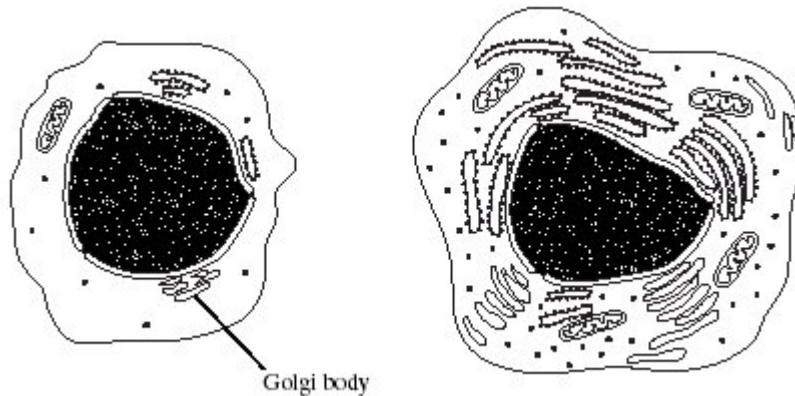

B lymphocyte before stimulation

B lymphocyte after stimulation

(i) Describe the role of macrophages in stimulating B lymphocytes.

(1)



- S (ii) Explain how the changes shown in the drawings are related to the function of B lymphocytes.

(4)

(Total 7 marks)

26

The drawing shows an electron micrograph of parts of epithelial cells from the small intestine.

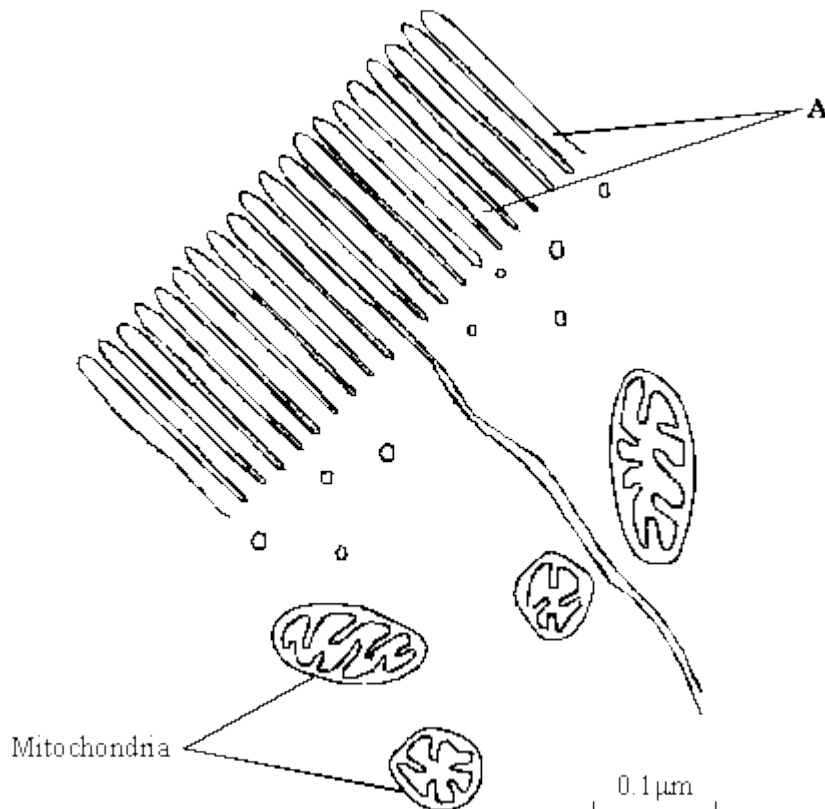

- (a) (i) Name the structures labelled A.

(1)



- (ii) Explain how these structures help in the absorption of substances from the small intestine.

(1)

- (b) (i) The scale bar on this drawing represents a length of $0.1\mu\text{m}$. Calculate the magnification of the drawing. Show your working.

Magnification _____

(2)

- (ii) Explain why an electron microscope shows more detail of cell structure than a light microscope.

(2)

- (c) The length of mitochondria can vary from $1.5\mu\text{m}$ to $10\mu\text{m}$ but their width never exceeds $1\mu\text{m}$. Explain the advantage of the width of mitochondria being no more than $1\mu\text{m}$.

(1)

(Total 7 marks)

- 27** **S** Gorter and Grendel investigated the structure of the surface membrane of cells. They extracted the phospholipids from the surface membranes of red blood cells in 1 cm^3 of blood and placed them in the apparatus shown in **Figure 1**.

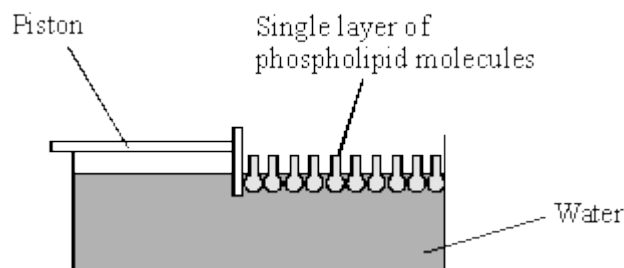

Figure 1



The piston was pushed across the surface of the water until the phospholipid molecules were tightly packed into a single layer. The area covered by the phospholipid molecules was measured. This area was compared with the estimated surface area of the red blood cells from which phospholipids were extracted.

Gorter and Grendel obtained the data shown in the table.

Number of red blood cells per cm^3 of blood	4.74×10^9
Estimated mean surface area of one red blood cell	$99.4 \mu\text{m}^2$
Surface area of membrane phospholipids extracted from 1cm^3 of blood	0.92 m^2

- (a) Explain what these data suggest about the arrangement of phospholipids in the surface membranes of red blood cells. Support your explanation with suitable calculations.

Show your working.

(3)



(b) **Figure 2** shows a red blood cell and a white blood cell.

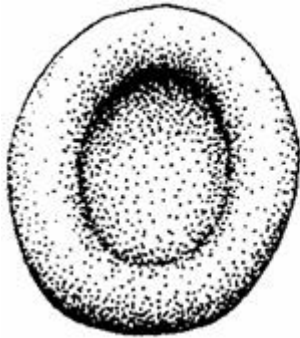

Red blood cell

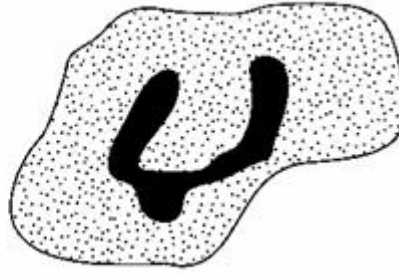

White blood cell

Figure 2

Explain why red blood cells were used in this investigation rather than white blood cells.

(2)
(Total 5 marks)



28

Giardiasis is an intestinal disease. It is caused by the microorganism *Giardia lamblia*. The drawing shows some of the structures present in *G. lamblia*.

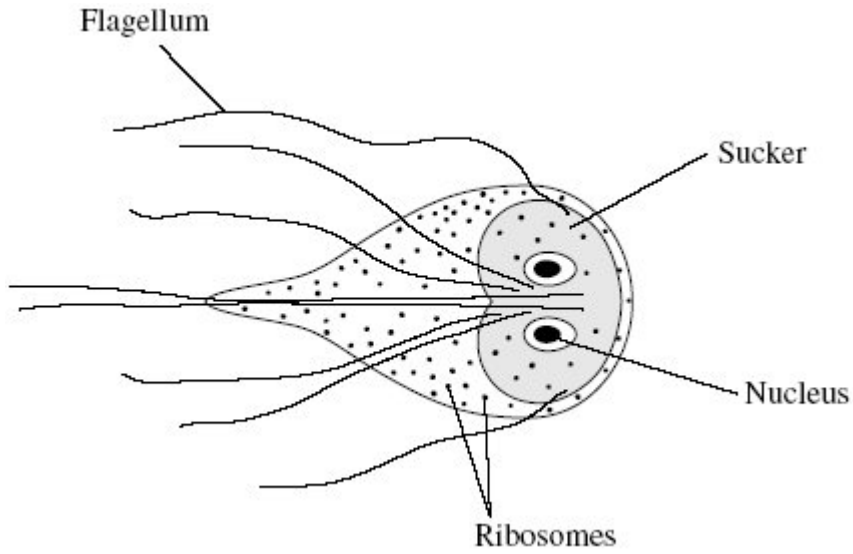

- (a) Name **one** structure shown in the drawing which confirms that *G. lamblia* is a eukaryotic organism.

(1)

- (b) *G. lamblia* can attach itself with its sucker. Explain how this is an adaptation to living in the intestines.

(1)



- (c) Giardiasis is one of the main causes of diarrhoea in the USA. It is usually transmitted by drinking contaminated water. The bar chart shows the number of cases of giardiasis in one state of the USA during one year.

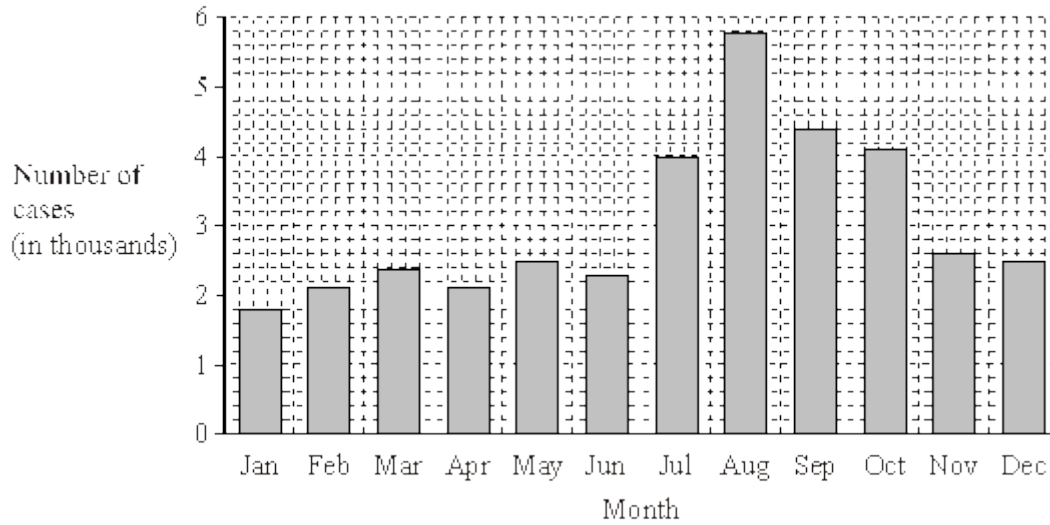

- (i) Calculate the percentage increase in the number of cases of giardiasis from January to August. Show your working.

Answer _____

(2)

- (ii) Suggest **one** reason for the number of cases being highest in the late summer months.

(1)



- (d) A test has been developed to find out whether a person is infected with *G. lamblia*. The test is shown in the flow chart.

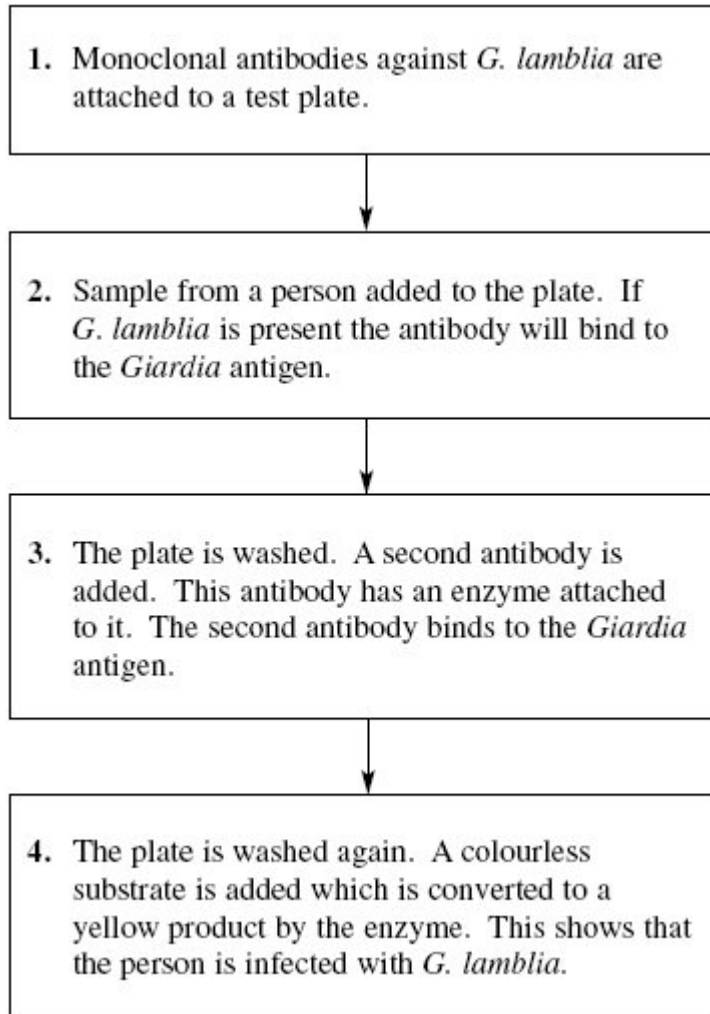

- (i) Explain why the antibodies used in this test must be monoclonal antibodies.

(1)

- (ii) Explain why the *Giardia* antigen binds to the antibody in step 2.

(1)



- (iii) The plate must be washed at the start of step 4, otherwise a positive result could be obtained when the *Giardia* antigen is not present. Explain why a positive result could be obtained if the plate is not washed at the start of step 4.

(2)

(Total 9 marks)

29

- (a) What is a tissue?

(1)

- (b) A student cut a thin section of tissue from a potato and examined it with an optical microscope.

- (i) Starch was present in the cells of this tissue. Describe how the student could find out where in the cells the starch was present.

(2)

- (ii) The student cut a thin section of the tissue. Explain why it was important that the section was thin.

(2)



(c) The cell walls of potato cells contain cellulose. Cellulose and starch are both carbohydrates. Describe **two** ways in which molecules of cellulose are similar to molecules of starch.

(2)

(Total 7 marks)

30

Scientists use optical microscopes and transmission electron microscopes (TEMs) to investigate cell structure. Explain the advantages and the limitations of using a TEM to investigate cell structure.

(Total 5 marks)